**User's
Manual**

Models UM351/UM331
Digital Indicator with Alarms
User's Manual



IM 05F01D12-41E

Blank Page

Introduction

Thank you for purchasing the UM351/UM331 digital indicator with alarms.

■ How to Use the Manuals

Purpose	Title	Description
Setup	1. Installation	Describes the tasks (installation, wiring, and others) required to make the indicator ready for operations.
Basic operation	2. Initial Settings	Describes examples of setting PV input types, and alarm types. Making settings described herein allows you to carry out basic monitoring.
Operating procedures and troubleshooting	3. Operations 4.1 Troubleshooting	Describes examples of setting alarm setpoints, as well as key operation necessary to run the indicator.
Brief operation and setpoint recording	5. Parameters	Contains the parameter map used as a guideline for setting parameters and lists of parameters for recording user settings.

■ Regarding This User's Manual

- (1) This manual should be provided to the end user. Keep an extra copy or copies of the manual in a safe place.
- (2) Read this manual carefully to gain a thorough understanding of how to operate this product before starting operation.
- (3) This manual describes the functions of this product. Yokogawa Electric Corporation (hereinafter simply referred to as Yokogawa) does not guarantee the application of these functions for any particular purpose.
- (4) Under absolutely no circumstances may the contents of this manual, in part or in whole, be transcribed or copied without permission.
- (5) The contents of this manual are subject to change without prior notice.
- (6) Every effort has been made to ensure that the details of this manual are accurate. However, should any errors be found or important information be omitted, please contact your nearest Yokogawa representative or our sales office.

■ Safety Precautions

The following symbol is indicated on the indicator to ensure safe use.



This symbol on the indicator indicates that the operator must refer to an explanation in the user's manual in order to avoid the risk of injury or death of personnel or damage to the instrument. The manual describes how the operator should exercise special care to avoid electric shock or other dangers that may result in injury or loss of life.

The following symbols are used in the hardcopy user's manuals and in the user's manual supplied on the CD-ROM.



Indicates that operating the hardware or software in a particular manner may damage it or result in a system failure.



Draws attention to information that is essential for understanding the operation and/or features of the indicator.

■ Force Majeure

- (1) Yokogawa assumes no liability to any party for any loss or damage, direct or indirect, caused by the use or any unpredictable defect of the product.
- (2) No portion of the software supplied by Yokogawa may be transferred, exchanged, leased or sublet for use by any third party without the prior permission of Yokogawa.
- (3) Be sure to use the spare parts approved by Yokogawa when replacing parts or consumables.
- (4) Use this software with one specified computer only. You must purchase another copy of the software for use on each additional computer.
- (5) Copying this software for purposes other than backup is strictly prohibited.
- (6) Store the floppy disk(s) (original medium or media) containing this software in a secure place.

■ Regarding Protection, Safety, and Prohibition Against Unauthorized Modification

- (1) In order to protect the product and the system controlled by it against damage and ensure its safe use, make certain that all of the instructions and precautions relating to safety contained in this document are strictly adhered to. Yokogawa does not guarantee safety if products are not handled according to these instructions.
- (2) Modification of the product is strictly prohibited.
- (3) Reverse engineering such as the disassembly or decompilation of software is strictly prohibited.

Blank Page

Models UM351/UM331 Digital Indicator with Alarms User's Manual

IM 05F01D12-41E 4th Edition

CONTENTS

Introduction	i
1. Installation	1-1
1.1 Model and Suffix Codes	1-1
1.2 How to Install	1-2
1.3 How to Connect Wires	1-5
1.4 Hardware Specifications	1-7
1.5 Terminal Wiring Diagrams	1-12
2. Initial Settings	2-1
2.1 Names and Functions of Front Panel Parts	2-2
2.2 Setting PV Input Type (Setting First at Power-on)	2-3
2.3 Changing PV Input Type	2-7
2.4 Changing Alarm Type	2-9
2.5 Setting Hysteresis in Alarm Setpoint	2-11
2.6 Setting the PV display color changing function "Active Color PV Display" ...	2-12
2.7 Setting the High Limit and Low limit for PV Color change	2-13
3. Operations	3-1
3.1 Monitoring-purpose Operating Display Available during Operation	3-1
3.2 Setting Alarm Setpoints	3-2
4. Troubleshooting and Maintenance	4-1
4.1 Troubleshooting	4-1
4.2 Maintenance	4-4
4.2.1 Cleaning	4-4
4.2.2 Replacing Brackets	4-4
4.2.3 Attaching Terminal Cover	4-4
4.2.4 Replacing Parts with a Limited Service Life	4-6
5. Parameters	5-1
5.1 Parameter Map	5-1
5.2 Lists of Parameters	5-2
Revision Information	i

Blank Page

1. Installation

This chapter describes installation, wiring, and other tasks required to make the indicator ready for operation.

1.1 Model and Suffix Codes

Before using the indicator, check that the model and suffix codes match your order.

Model	Suffix Code	Description
UM351		Digital indicator with Alarms (provided with retransmission output and 15 V DC loop power supply as standard)
UM331		
Type	-0	Standard type with three alarms
	-3	Standard type with three alarms (with 24 V DC loop power supply)
Optional functions	0	None
	1	With communication and additional alarm-4
	2	With additional alarm-4

Check that the following items are provided:

- Digital indicator with alarms (of ordered model) 1
- Brackets (mounting hardware) 1 pair
- Unit label 1
- User’s Manuals 3 (A2 size)
- User’s Manuals
“Setting/Explanation of Active Color PV Display 1 (A3 size)
- User’s Manual (Reference) (CD-ROM version)
(only for indicators with optional communication functions) ... 1

1.2 How to Install

 **NOTE**

To install the indicator, select a location where:

1. no one may accidentally touch the terminals,
2. mechanical vibrations are minimal,
3. corrosive gas is minimal,
4. temperature can be maintained at about 23°C and the fluctuation is minimal,
5. no direct radiant heat is present,
6. no magnetic disturbances are caused,
7. no wind blows against the terminal board (reference junction compensation element),
8. no water is splashed,
9. no flammable materials are around,

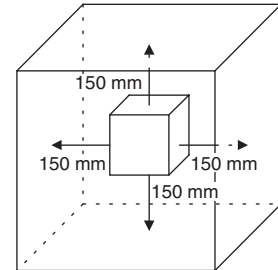

Never place the indicator directly on flammable items or equipment.

If the indicator has to be installed close to flammable items or equipment, be sure to provide shielding panels all around the indicator, at least 150 mm away from every side; the panels should be made of either 1.43 mm-thick metal-plated steel plates or 1.6 mm-thick uncoated steel plates.

 **NOTE**

Never touch the opening at the bottom of the case. It is to be used in the factory at shipping.

● Installation Position

Install the indicator at an angle within 30° from horizontal with the front panel facing upward. Do not install it facing downward. The position of right and left sides should be horizontal.

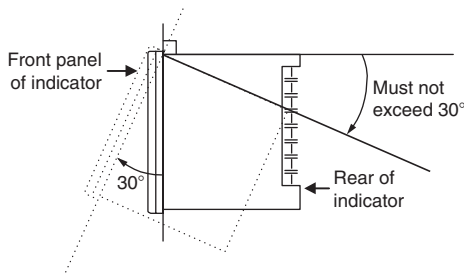

External Dimensions and Panel Cutout Dimensions

UM351

Unit: mm

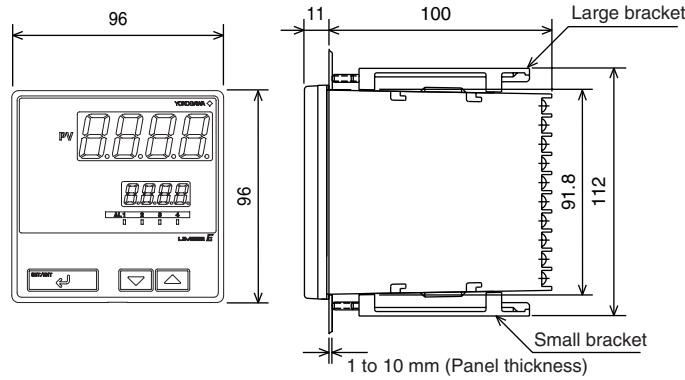

General installation

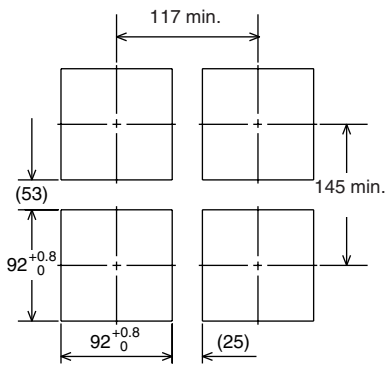

Side-by-side close installation

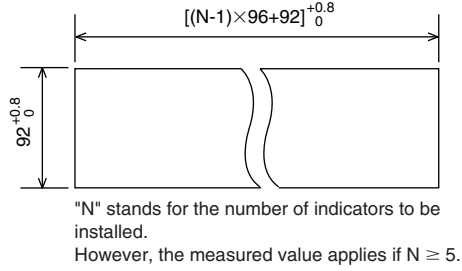

UM331

Unit: mm

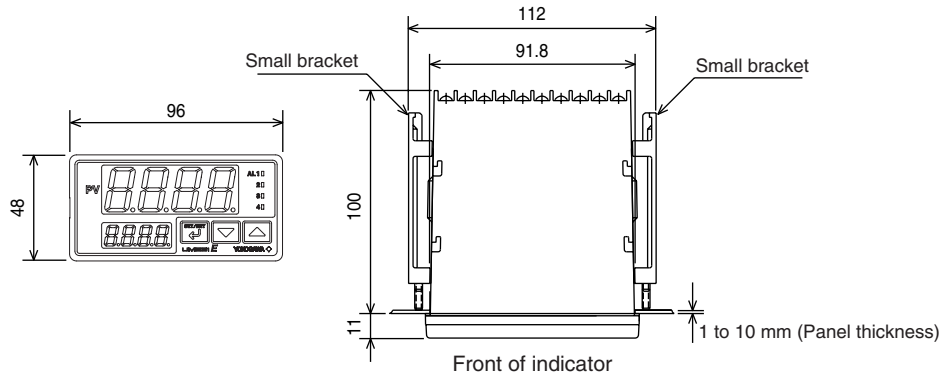

General installation

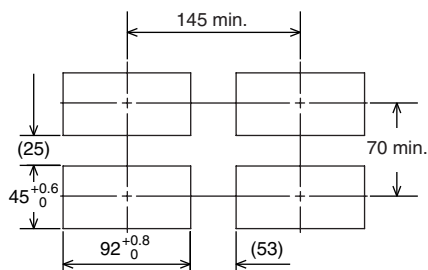

■ How to Install



CAUTION

Turn off the power to the indicator before installing it on the panel because there is a possibility of electric shock.

After opening the mounting hole on the panel, follow the procedures below to install the indicator:

1. Insert the indicator into the opening from the front of the panel so that the terminal board on the rear is at the far side.
2. Set the brackets in place on the top and bottom of the indicator as shown in the figure below, then tighten the screws of the brackets. Take care not to overtighten them.

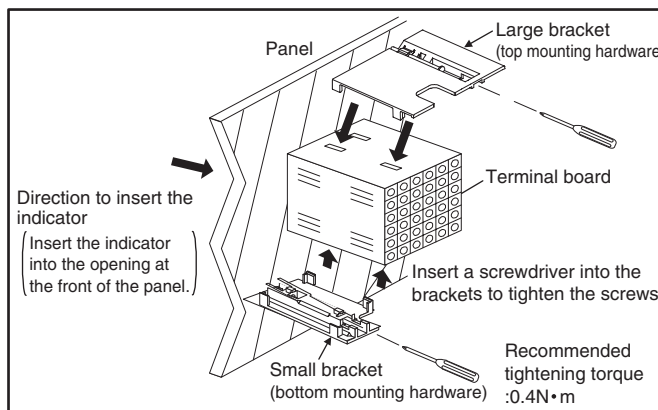

Note: Right and left mounting for UM331.

1.3 How to Connect Wires



- 1) Before carrying out wiring, turn off the power to the indicator and check that the cables to be connected are not alive with a tester or the like because there is a possibility of electric shock.
- 2) Wiring must be carried out by personnel who have basic electrical knowledge and practical experience.

NOTE

- 1) Provide power from a single-phase instrument power supply. If there is a lot of noise in the power line, insert an insulating transformer into the primary side of the line and use a line filter (recommended part: ZAC2205-00U from TDK) on the secondary side. As a countermeasures against noise, do not place the primary and secondary power cables close to each other.
- 2) For thermocouple input, use shielded compensating lead wires for wiring. For RTD input, use shielded wires that have low conductor resistance and cause no significant differences in resistance between the three wires. The cables to be used for wiring, terminal specifications, and recommended parts are as shown below.
- 3) Alarm output relays have a life of 100,000 times that of the resistance load, use auxiliary relays to turn on/off a load.
- 4) The use of inductance (L) loads such as auxiliary relays, motors and solenoid valves causes malfunction or relay failure; always insert a CR filter for use with alternating current or a diode for use with direct current, as a spark-removal surge suppression circuit, into the line in parallel with the load.
- 5) When there is possibility of being struck by external lightening surge, use the arrester to protect the instrument.

■ For DC Relay Wiring

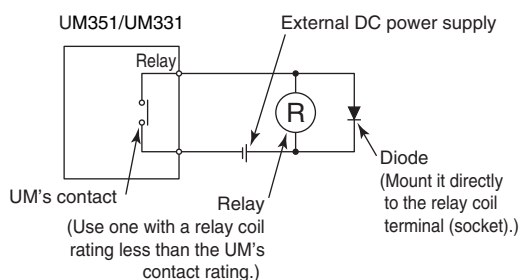

■ For AC Relay Wiring

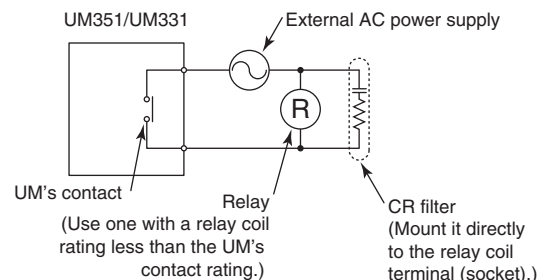

● Cable Specifications and Recommended Cables

Purpose	Name and Manufacturer
Power supply, grounding, relay contact outputs	600 V PVC insulated wires, JIS C 3307, 0.9 to 2.0 mm ²
Thermocouple	Shielded compensating lead wires, JIS C 1610, □X-□-□-□ (See Yokogawa Electric's GS 6B1U1-E.)
RTD	Shielded wires (three conductors), UL2482 (Hitachi Cable)
Other signals	Shielded wires

● Recommended Terminal Lugs

Applicable wire size	Tightening torque
0.3 to 1.65 mm ²	0.8 N·m or less

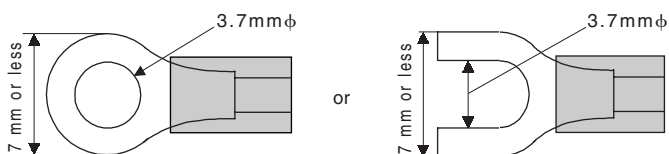

● Terminal Covers (Optional parts)

Target Model	Part Number	Sales Unit
UM351	T9115YD	1
UM331	T9115YE	1

1.4 Hardware Specifications

PV Input Signals

- Number of inputs: 1 (terminals ①①-①②-①③)
- Input type: Universal input system. The input type can be selected with the software.
- Sampling period: 250 ms
- Burnout detection: Functions at TC, RTD, standard signal (0.4 to 2 V or 1 to 5 V)
Upscale, downscale, and off can be specified.
For standard signal, burnout is determined to have occurred if it is 0.1 V or less.
- Input bias current: 0.05 μA (for TC or RTD b-terminal)
- Measurement current (RTD): About 0.13 mA
- Input resistance: 1 M Ω or more for thermocouple or mV input
About 1 M Ω for DC voltage input
- Allowable signal source resistance: 250 Ω or less for thermocouple or mV input
Effects of signal source resistance: 0.1 $\mu\text{V}/\Omega$ or less
2 k Ω or less for DC voltage input
Effects of signal source resistance: About 0.01%/100 V
- Allowable wiring resistance: for RTD input
Maximum 150 Ω /wire: Conductor resistance between three wires should be equal
However, 10 Ω /wire for a maximum range of -150.0 to 150.0°C.
Wire resistance effect: $\pm 0.1^\circ\text{C}/10 \Omega$
- Allowable input voltage: ± 10 V DC for thermocouple, mV, or RTD input
 ± 20 V DC for DC voltage input
- Noise rejection ratio: 40 dB (50/60 Hz) or more in normal mode
120 dB (50/60 Hz) or more in common mode
- Reference junction compensation error: $\pm 1.0^\circ\text{C}$ (15 to 35°C)
 $\pm 1.5^\circ\text{C}$ (0 to 15°C, 35 to 50°C)
- Applicable standards: JIS, IEC, DIN (ITS-90) for thermocouples and RTD

Loop Power Supply

Power is supplied to a two-wire transmitter.

(15 V DC: terminals ①⑥-①⑦; 24 V DC: terminals ②①-②②)

A resistor (10 to 250 Ω) connected between the indicator and transmitter converts a current signal into a voltage signal, which is then read via the PV input terminal.

Supply voltage: 14.5 to 18.0 V DC, max. 21 mA (provided with a protection circuit against a field short-circuit); 21.6 to 28.0 V DC, max. 30 mA (only for models with 24 V DC loop power supply)

Retransmission Output

Outputs the PV value.

Either the retransmission output or the loop power supply can be used with terminals ⑩-⑪.

- Number of outputs: 1 (terminals ⑩-⑪)
- Output signal: 4-20 mA DC
- Load resistance: 600 Ω or less
- Output accuracy: $\pm 0.3\%$ of span under standard operating conditions ($23\pm 2^\circ\text{C}$, $55\pm 10\%$ RH, power frequency of 50/60 Hz)

Contact Inputs

- Purpose: Resetting of PV peak and bottom values
- Number of inputs: 1
- Input type: Non-voltage contact or transistor open collector input
- Input contact rating: 12 V DC, 10 mA or more
- On/off determination: For non-voltage contact input, contact resistance of 1 k Ω or less is determined as "on" and contact resistance of 20 k Ω or more as "off."
For transistor open collector input, input voltage of 2 V or less is determined as "on" and leakage current must not exceed 100 μA when "off."
- Minimum status detection hold time: About 1 second

Contact Outputs

- Purpose: Alarm output, FAIL output, and others
- Number of outputs: 4 (Max).
- Relay contact rating for Alarm 1 to 3: 240 V AC, 1 A, or 30 V DC, 1 A; 1a
- Relay contact rating for Alarm 4: 250 V AC, 3 A, or 30 V DC, 3 A (resistance load) 3 terminals (NC, NO, Common); 1c, (FAIL output : 1b)

Display Specifications

- PV display: 4-digit, 7-segment red LED display, character height of 20 mm (for both UM351 and UM331)
- Setpoint display: 4-digit, 7-segment, red LEDs, character height of 9.3 mm (for both UM351 and UM331)
- Status indicating lamps: LEDs

Safety and EMC Standards

- Safety: Complies with IEC/EN61010-1 (CE), approved by C22.2 No.61010-1, approved by UL508.

Installation category : CAT. II Pollution degree : 2 (IEC/EN61010-1, C22.2 No.61010-1)

Measurement category : I (CAT. I : IEC/EN61010-1)

Rated measurement input voltage : 10V DC max.(across terminals), 300V AC max.(across ground)

Rated transient overvoltage : 1500V (Note)

Note : It is a value on the safety standard which is assumed by IEC/EN61010-1 in Measurement category I, and is not the value which guarantees an apparatus performance.



CAUTION

This equipment has Measurement category I, therefore do not use the equipment for measurements within Measurement categories II, III and IV.

Measurement category		Description	Remarks
I	CAT. I	For measurements performed on circuits not directly connected to MAINS.	
II	CAT. II	For measurements performed on circuits directly connected to the low voltage installation.	Appliances, portable equipments, etc.
III	CAT. III	For measurements performed in the building installation.	Distribution board, circuit breaker, etc.
IV	CAT. IV	For measurements performed at the source of the low-voltage installation.	Overhead wire, cable systems, etc.

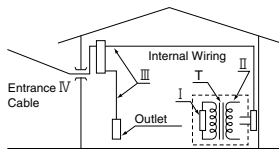

- EMC standards: Complies with EN61326, EN61000-3-2, EN61000-3-3 and EN55011 (CE).
AS/NZS 2064 compliant (C-Tick).
Class A Group 1.

The instrument continues to operate at a measuring accuracy of within $\pm 20\%$ of the range during tests.

Construction, Installation, and Wiring

- Construction: Dust-proof and drip-proof front panel conforming to IP55. For side-by-side close installation the indicator loses its dust-proof and drip-proof protection.
- Material: ABS resin and polycarbonate
- Case color: Black
- Weight: About 1 kg or less
- Dimensions:
UM351 — 96 (W) × 96 (H) × 100 (depth from panel face) mm
UM331 — 96 (W) × 48 (H) × 100 (depth from panel face) mm
- Installation: Panel-mounting type. With top and bottom (or right and left) mounting hardware (1 each)
- Panel cutout dimensions:
UM351 — $92^{+0.8}_0$ (W) × $92^{+0.8}_0$ (H) mm
UM331 — $92^{+0.8}_0$ (W) × $45^{+0.6}_0$ (H) mm
- Installation position: Up to 30° upward facing (not designed for facing downward)
- Wiring: M3.5 screw terminals (for signal wiring and power/ground wiring as well)

Power Supply Specifications

- Power supply: Rated voltage of 100 to 240 V AC ($\pm 10\%$), 50/60 Hz
- Power consumption: Max. 20 VA (8.0 W max.)
- Internal fuse rating: 250 VAC, 1.6A time-lag fuse
- Data backup: Non-volatile memory (can be written to up to 100,000 times)
- Withstanding voltage
 - Between primary terminals* and secondary terminals**:
At least 1500 V AC for 1 minute
 - Between primary terminals* and grounding terminal:
At least 1500 V AC for 1 minute
 - Between grounding terminal and secondary terminals**:
At least 1500 V AC for 1 minute
 - Between secondary terminals**:
At least 500 V AC for 1 minute
- * Primary terminals indicate power terminals and relay output terminals
- ** Secondary terminals indicate analog I/O signal, and contact input terminals
- Insulation resistance: 20 M Ω or more at 500 V DC between power terminals and grounding terminal
- Grounding: Class D grounding (grounding resistance of 100 Ω or less)

Signal Isolations

- PV input terminals: Isolated from other input/output terminals. Not isolated from internal circuit.
- 15 V DC loop power supply terminals: Not isolated from 4-20 mA analog output. Isolated from other input/output terminals and internal circuit.
- 24 V DC loop power supply terminals: Isolated from 4-20 mA analog output terminals, other input/output terminals and internal circuit.
- 4-20 mA analog output terminals (for retransmission): Not isolated from 15 V DC loop power supply. Isolated from other input/output terminals and internal circuit.
- Contact input terminals: Not isolated from communication terminals. Isolated from other input/output terminals and internal circuit.
- Relay contact output terminals: Not isolated between relay contact output terminals. Isolated from other input/output terminals and internal circuit.
- RS-485 communication terminals: Not isolated from contact input terminals. Isolated from other input/output terminals and internal circuit.
- Power terminals: Isolated from other input/output terminals and internal circuit.
- Grounding terminals: Isolated from other input/output terminals and internal circuit.

Environmental Conditions

- Normal operating conditions:
 - Ambient temperature: 0 to 50°C (40°C or less for side-by-side close installation)
0 to 40°C if the 24 V DC loop power supply of Model UM331 is used
 - Temperature change rate: 10°C/h or less
 - Ambient humidity: 20 to 90% RH (no condensation allowed)
 - Magnetic field: 400 A/m or less
 - Continuous vibration at 5 to 14 Hz: Full amplitude of 1.2 mm or less
 - Continuous vibration at 14 to 150 Hz: 4.9 m/s² or less
 - Short-period vibration: 14.7 m/s², 15 seconds or less
 - Shock: 147 m/s² or less, 11 ms
 - Installation height: Height above sea level of 2000 m or less
 - Warm-up time: 30 minutes or more after power on
- Transportation and storage conditions:
 - Temperature: -25 to 70°C
 - Temperature change rate: 20°C/h or less
 - Humidity: 5 to 95% RH (no condensation allowed)
- Effects of changes in operating conditions
 - Effects from changes in ambient temperature:
 - On voltage or thermocouple input, $\pm 1 \mu\text{V}/^\circ\text{C}$ or $\pm 0.01\%$ of F.S./ $^\circ\text{C}$, whichever is larger
 - On RTD input, $\pm 0.05^\circ\text{C}/^\circ\text{C}$ (ambient temperature) or less
 - On analog output, $\pm 0.05\%$ of F.S./ $^\circ\text{C}$ or less
 - Effects from power supply fluctuation (within rated voltage range)
 - On analog input, $\pm 1 \mu\text{V}/10 \text{ V}$ or $\pm 0.01\%$ of F.S./10 V, whichever is larger
 - On analog output, $\pm 0.05\%$ of F.S./10 V or less

1.5 Terminal Wiring Diagrams



NOTE

Do not use unassigned terminals as relay terminals.

Terminal wiring diagrams are shown on and after the next page.

■ UM351 Standard Type (Model UM351-0□ or UM351-3□)

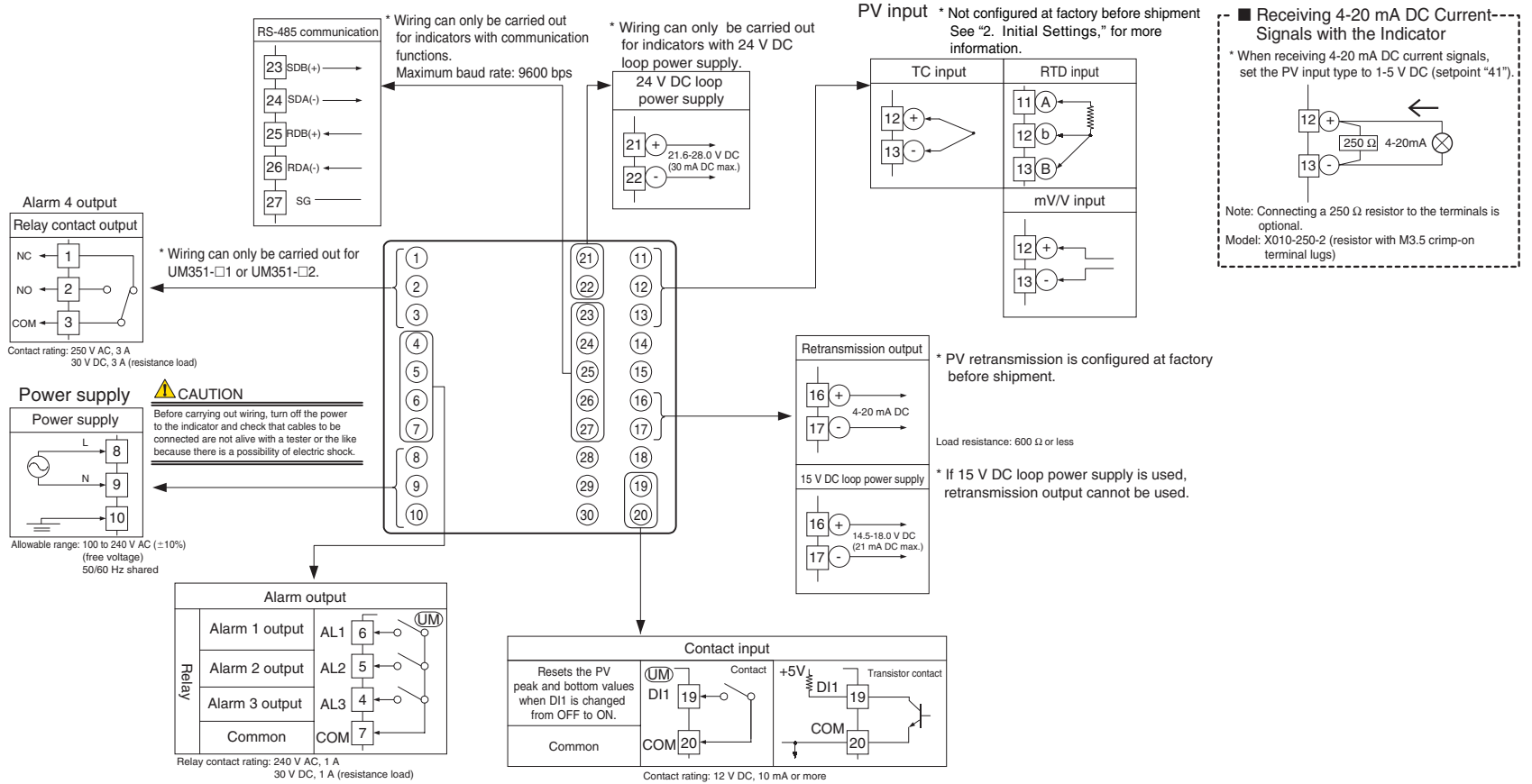

■ UM331 Standard Type (Model UM331-0□ or UM331-3□)

■ Receiving 4-20 mA DC Current Signals with the Indicator

* When receiving 4-20 mA DC current signals, set the PV input type to 1-5 V DC (setpoint "41").

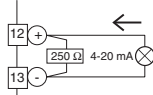

Note: Connecting a 250 Ω resistor to the terminals is optional.
Model: X010-250-2 (resistor with M3.5 crimp-on terminal lugs)

PV input * Not configured at factory before shipment
See "2. Initial Settings," for more information.

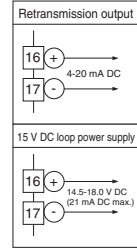
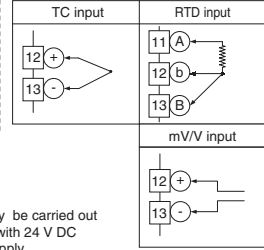

* PV retransmission is configured at factory before shipment.

Load resistance: 600 Ω or less

* If 15 V DC loop power supply is used, retransmission output cannot be used.

* Wiring can only be carried out for indicators with 24 V DC loop power supply.

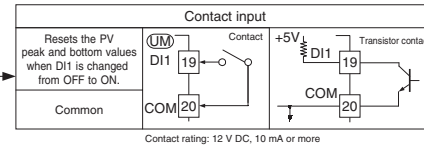
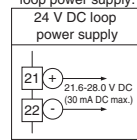

Contact rating: 12 V DC, 10 mA or more

* Wiring can only be carried out for indicators with communication functions.
Maximum baud rate: 9600 bps

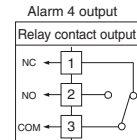

Contact rating: 250 V AC, 3 A
30 V DC, 3 A (resistance load)

* Wiring can only be carried out for UM331-□1 or UM331-□2.

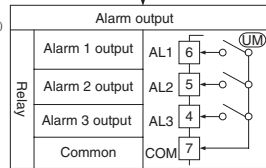

Relay contact rating: 240 V AC, 1 A
30 V DC, 1 A (resistance load)

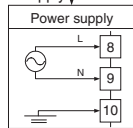

Allowable range: 100 to 240 V AC (±10%)
(free voltage)
50/60 Hz shared

CAUTION
Before carrying out wiring, turn off the power to the indicator and check that cables to be connected are not alive with a tester or the like because there is a possibility of electric shock.

* Wiring can only be carried out for indicators with 24 V DC loop power supply.

■ 15 V DC Power Supply Wiring to Two-wire Sensor

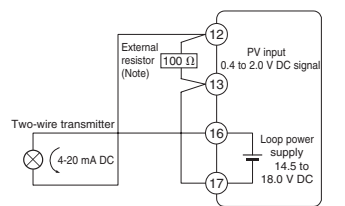

Note: Connecting a 100 Ω resistor to the terminals is optional.
Model: X010-100-2 (resistor with M3.5 crimp-on terminal lugs)

■ 24 V DC Power Supply Wiring to Two-wire Sensor

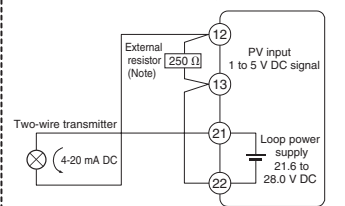

Note: Connecting a 250 Ω resistor to the terminals is optional.
Model: X010-250-2 (resistor with M3.5 crimp-on terminal lugs)

2. Initial Settings

This chapter describes examples of setting the types of PV input and alarm. Carrying out settings described herein allows you to perform basic monitoring. Refer to examples of various settings to understand how to set parameters required. Refer to “5.1 Parameter Map” for an easy to understand explanation of setting various parameters. If you cannot remember how to carry out an operation during setting, press the  key for more than 3 seconds. This brings you to the display (operating display) that appears at power-on.

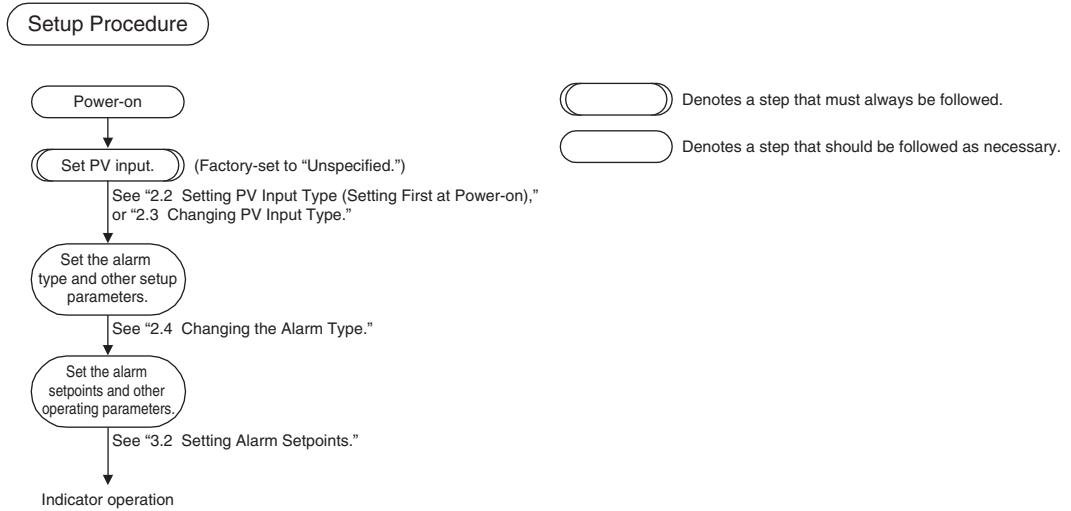

The following explanation of operation for the UM351’s panel, shown in the figure, is the same as that of the UM331’s panel.

2.1 Names and Functions of Front Panel Parts

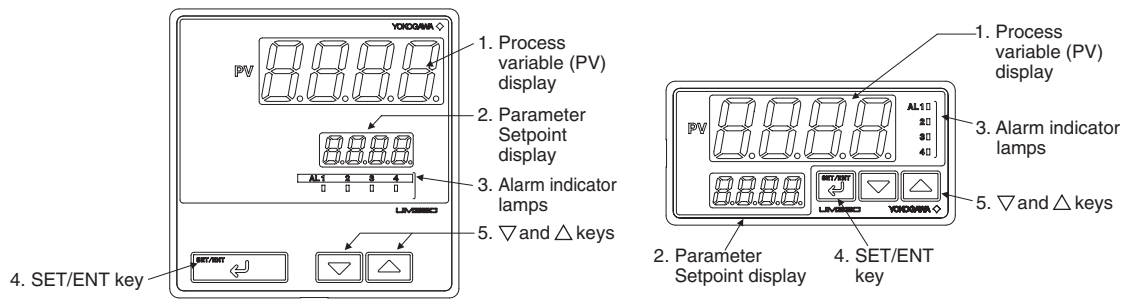

Name of Part	Function
1. Process variable (PV) display	<ul style="list-style-type: none"> • Displays a PV value during operation. • Displays a parameter symbol when you set a parameter. • Displays an error code in red if the indicator fails.
2. Parameter setpoint display	Displays the setpoint of a parameter when it is configured.
3. Alarm indicator lamps	If any of alarms 1 to 4 occurs, the respective alarm indicator lamp (AL1 to AL4) is lit (in orange).
4. SET/ENT key	Used to switch or register a parameter. Pressing the key for more than 3 seconds allows you to switch between the operating display and the menu for operating parameter setting display alternately.
5. ▽ and △ keys	Used to change numerical values. On setting displays for various parameters, you can change parameters. Pressing the ▽ key decreases a numerical value, while pressing the △ key causes it to increase. You can hold down a key to gradually increase the speed of change.





IMPORTANT

The indicator automatically returns to the display at the time of power-on (i.e., Operating display) if no key is operated for at least one minute.

2.2 Setting PV Input Type (Setting First at Power-on)

NOTE

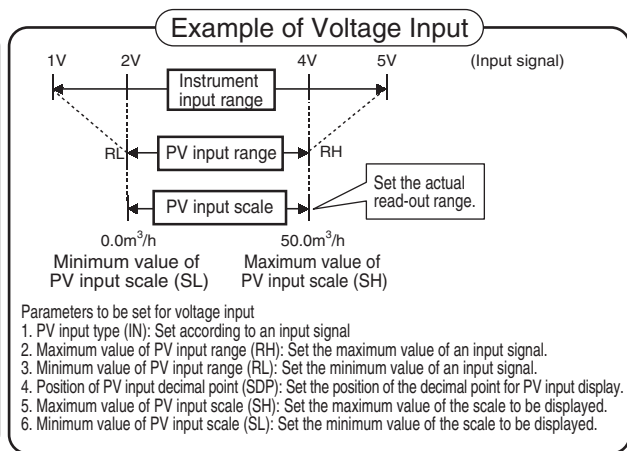
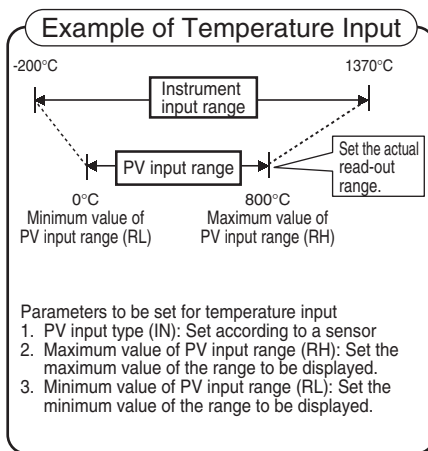

- The indicator displays the operating display when the power is turned on. However, if PV input type has not been set, “IN” appears. In this case, first use the  key to display the input range code to use, then press the  key to register it. Then, set the maximum value (RH) and minimum value (RL) of the PV input range (for voltage input, set the maximum value (SH) and minimum value (SL) of the PV input scale).
- The indicator is configured to the initial value of each parameter at the factory before shipment. First check the initial values shown in “5.2 Lists of Parameters,” and change parameter values as necessary.

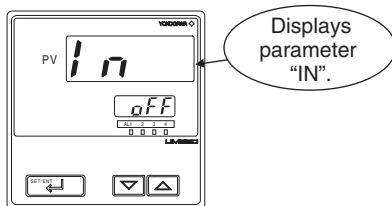

The following operating procedure describes an example of setting a K-type thermocouple (-199.9°C to 500.0°C) and a measurement range of 0.0°C to 200.0°C.

1. **Display screen at power-on**
The parameter “IN” for setting the PV input type appears.



2. **Press the  or  key to display the required setpoint.**
The figure below shows an example of setting a K-type thermocouple (-199.9 to 500.0°C). See the Instrument Input Range Codes.

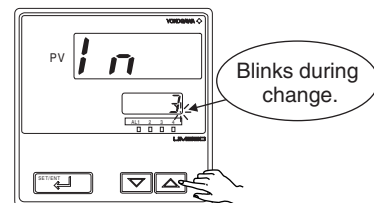

- 3. Press the  key once to register the setpoint.

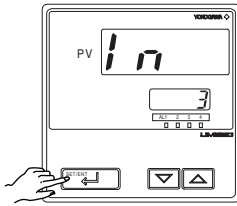

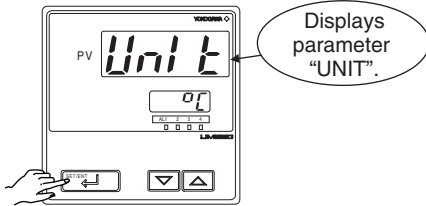

- 4. Press the  key once to display the parameter "UNIT" (PV input unit).

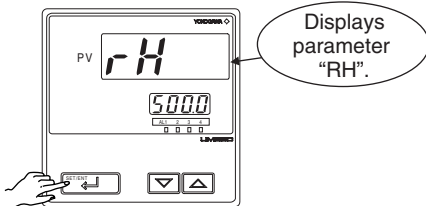

- 5. Press the  key once to display the parameter "RH" (maximum value of PV input range).



- 6. Press the  or  key to display the required setpoint. The figure below shows an example of setting the maximum value of PV input range to 200.0°C.

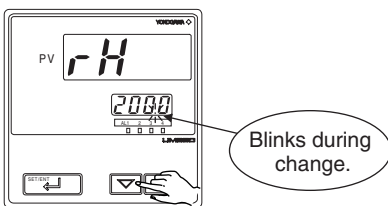

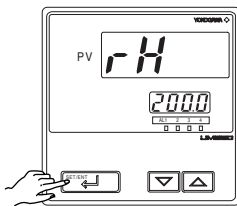

- 7. Press the  key once to register the setpoint.

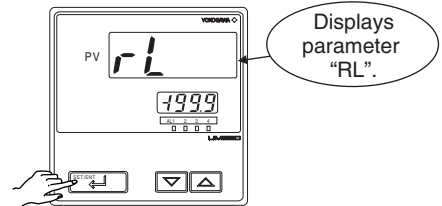

- 8. Press the  key once to display the parameter "RL" (minimum value of PV input range).



- 9. Press the  or  key to display the required setpoint. The figure below shows an example of setting the minimum value of PV input range to 0.0°C.

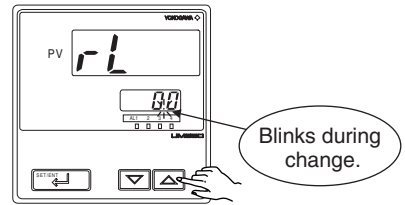

- 10. Press the  key once to register the setpoint.

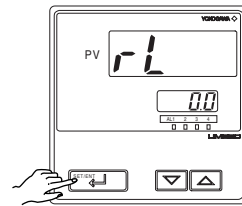

If the type of input is voltage, also configure the PV Input Decimal Point Position (SDP), Maximum Value of PV Input Scale (SH), and Minimum Value of PV Input Scale (SL) parameters that are displayed after this.

- 11. Press the  key for more than 3 seconds. This returns you to the display shown at power-on (figure below).

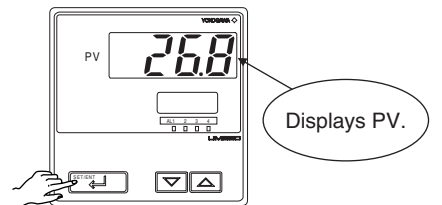

The PV display in the figure above shows the error code for input burnout (*boUt*) if PV input wiring is not yet complete. The error code disappears when you wire the PV input terminals correctly.

Instrument Input Range Codes

Selected the unit from UNIT parameter.

Input	Type	Instrument Input Range Code	Instrument Input Range	Measurement Accuracy
Unspecified		OFF	Set the data item PV Input Type "IN" to the OFF option to leave the PV input type undefined.	
Thermocouple	K	1	-200 to 1370°C -300 to 2500°F	±0.1% of instrument range ±1 digit for temperatures equal to or higher than 0°C ±0.2% of instrument range ±1 digit for temperatures below 0°C
		2	-199.9 to 999.9°C 0 to 2300°F	
		3	-199.9 to 500.0°C -199.9 to 999.9°F	
	J	4	-199.9 to 999.9°C -300 to 2300°F	
		T	5	
	6		0.0 to 400.0°C -199.9 to 750.0°F	
	B	7	0 to 1800°C 32 to 3300°F	±0.15% of instrument range ±1 digit for temperatures equal to or higher than 400°C ±5% of instrument range ±1 digit for temperatures below 400°C
	S	8	0 to 1700°C 32 to 3100°F	±0.15% of instrument range ±1 digit
	R	9	0 to 1700°C 32 to 3100°F	
	N	10	-200 to 1300°C -300 to 2400°F	±0.1% of instrument range ±1 digit ±0.25% of instrument range ±1 digit for temperatures below 0°C
	E	11	-199.9 to 999.9°C -300 to 1800°F	±0.1% of instrument range ±1 digit for temperatures equal to or higher than 0°C ±0.2% of instrument range ±1 digit for temperatures below 0°C
	L(DIN)	12	-199.9 to 900.0°C -300 to 1300°F	
			-199.9 to 400.0°C -300 to 750°F	
	U(DIN)	14	0.0 to 400.0°C -199.9 to 750.0°F	
			13	0 to 2300°C 32 to 4200°F
	W	15	0 to 1390°C 32 to 2500°F	±0.1% of instrument range ±1 digit
	Platinel 2	16	0 to 1900°C 32 to 3400°F	±0.5% of instrument range ±1 digit for temperatures equal to or higher than 800°C No guarantee of accuracy for temperatures below 800°C
	PR20-40	17	0 to 2000°C 32 to 3600°F	±0.2% of instrument range ±1 digit
W97Re3- W75Re25	18	-199.9 to 500.0°C -199.9 to 999.9°F	±0.1% of instrument range ±1 digit (Note 1) (Note 2)	
RTD	JPt100	30	-150.0 to 150.0°C -199.9 to 300.0°F	±0.2% of instrument range ±1 digit (Note 1)
		31	-199.9 to 850.0°C -300 to 1560°F	±0.1% of instrument range ±1 digit (Note 1) (Note 2)
	Pt100	35	-199.9 to 500.0°C -199.9 to 999.9°F	
		36	-150.0 to 150.0°C -199.9 to 300.0°F	±0.2% of instrument range ±1 digit (Note 1)
		37		
Standard signal	0.4 to 2 V	40	0.400 to 2.000 V	±0.1% of instrument range ±1 digit The read-out range can be scaled between -1999 and 9999.
	1 to 5 V	41	1.000 to 5.000 V	
DC voltage	0 to 2 V	50	0.000 to 2.000 V	
	0 to 10 V	51	0.00 to 10.00 V	
	-10 to 20 mV	55	-10.00 to 20.00 mV	
	0 to 100 mV	56	0.0 to 100.0 mV	

* Performance in the standard condition (at 23±2°C, 55±10%RH, and 50/60 Hz power frequency).

Note 1: The accuracy is ±0.3°C of instrument range ±1 digit for a temperature range from 0°C to 100°C.

Note 2: The accuracy is ±0.5°C of instrument range ±1 digit for a temperature ranges from -100°C to 0°C and 100°C to 200°C.

* To receive a 4-20 mA DC signal, select a standard signal of 1 to 5 V DC and connect it to a 250 Ω resistor. This resistor is optional.

Model: X010-250-2 (resistor with M3.5 crimp-on terminal lugs)

**NOTE**

The indicator may automatically initialize the registered operating parameter setpoints if any change is made to the data item PV Input Type (IN), Maximum Value of PV Input Range (RH), Minimum Value of PV Input Range (RL), PV Input Decimal Point Position (SDP), Maximum Value of PV Input Scale (SH) or Minimum Value of PV Input Scale (SL). After a change has been made to any of these data items, be sure to verify the registered operating parameter setpoints to ensure that they are correct. If any data item has been changed to its default, set it to a required value.

2.3 Changing PV Input Type

The following operating procedure describes an example of changing the setting of K-type thermocouple (-199.9 to 500.0°C) to RTD Pt100 (-199.9 to 500.0°C) and a measurement range of 0.0 to 200.0°C.

PV input terminal	
Thermocouple/mV/V input.....	⑫-⑬
RTD input	⑪-⑫-⑬

1. Bring the operating display into view (display appears at power on).

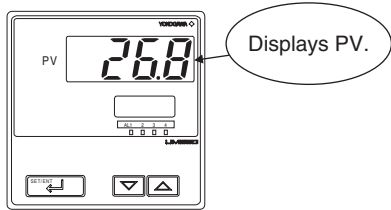

2. Press the **SET/ENT** key for more than 3 seconds to call up the menu "OP.PA".

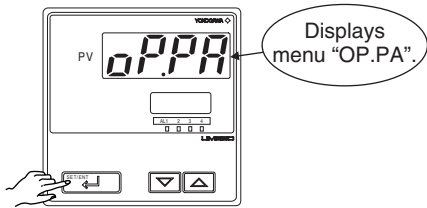

3. Press the **▲** key once to display the menu "STUP".

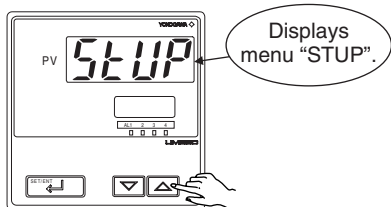

4. Press the **SET/ENT** key once to display the parameter "PWD".

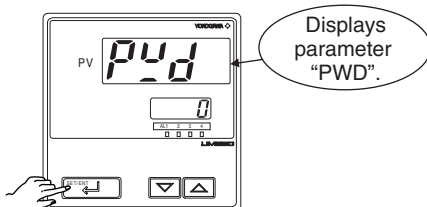

5. Press the **SET/ENT** key once to display the menu "FUNC".

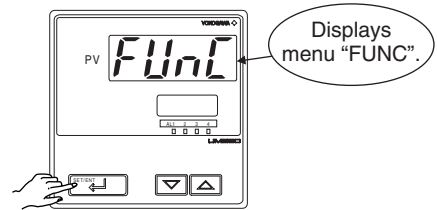

6. Press the **▲** key once to display the menu "I/O".

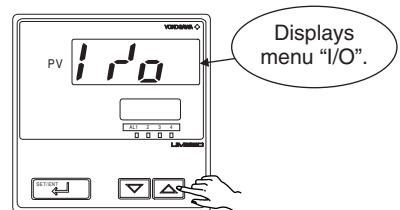

7. Press the **SET/ENT** key once to display the parameter "IN" (PV input type).

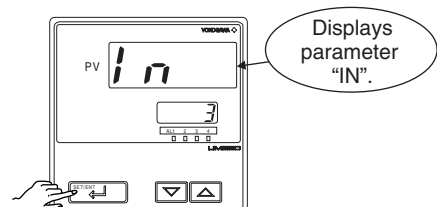

8. Press the **▲** or **▼** key to display the required setpoint. The figure below shows an example of changing to RTD Pt100 (-199.9 to 500.0°C).

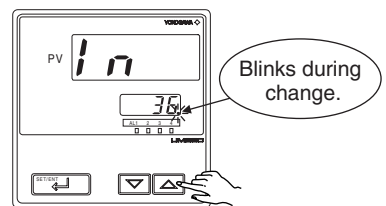

- 9. Press the  key once to register the setpoint.

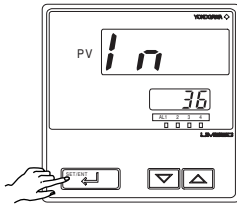

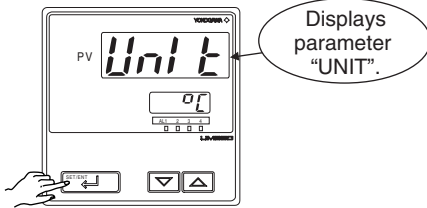

- 10. Press the  key once to display the parameter "UNIT" (PV input unit).

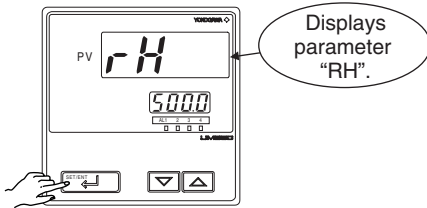

- 11. Press the  key once to display the parameter "RH" (maximum value of PV input range).



- 12. Press the  or  key to display the required setpoint. The figure below shows an example of setting the maximum value of PV input range to 200.0°C.

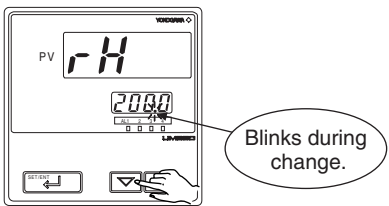

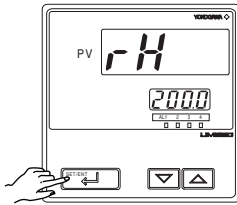

- 13. Press the  key once to register the setpoint.

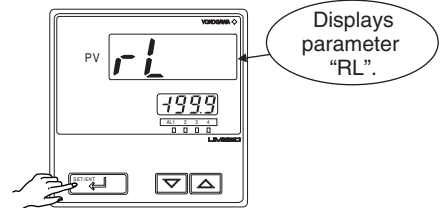

- 14. Press the  key once to display the parameter "RL" (minimum value of PV input range).



- 15. Press the  or  key to display the required setpoint. The figure below shows an example of setting the minimum value of PV input range to 0.0°C.

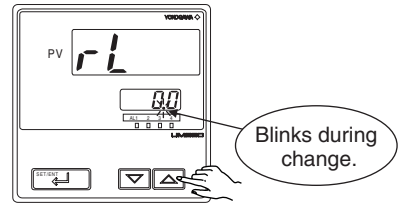

- 16. Press the  key once to register the setpoint.

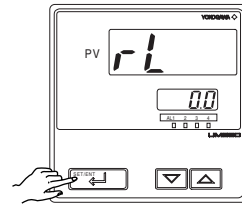

- 17. Press the  key for more than 3 seconds. This returns you to the display shown at power-on (figure below).

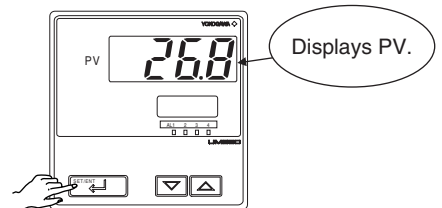

* If the type of input is voltage, also configure the PV Input Decimal Point Position (SDP), Maximum Value of PV Input Scale (SH), and Minimum Value of PV Input Scale (SL) parameters that are displayed after this.

2.4 Changing Alarm Type

The following operating procedure describes an example of changing alarm-1 (factory-set default: PV high limit alarm) to PV low limit alarm.

When you have changed alarm type, the alarm setpoint will be initialized; set the alarm setpoint again.

Alarm output terminals	Factory-set defaults
Alarm-1 (terminal numbers ⑥-⑦)PV high limit alarm
Alarm-2 (terminal numbers ⑤-⑦)PV low limit alarm
Alarm-3 (terminal numbers ④-⑦)PV high limit alarm
Alarm-4 (terminal numbers ①-②-③)PV low limit alarm

1. Bring the operating display into view (appears at power-on).

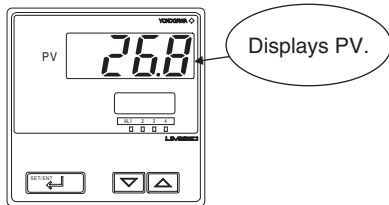

2. Press the key for **more than 3 seconds** to call up the menu "OP.PA".

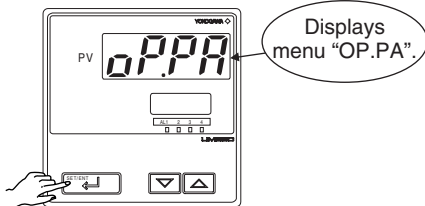

3. Press the key once to display the menu "STUP".

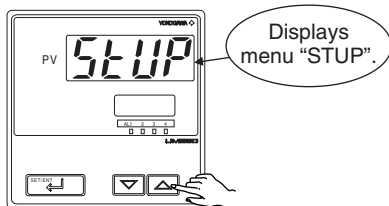

4. Press the key once to display the parameter "PWD".

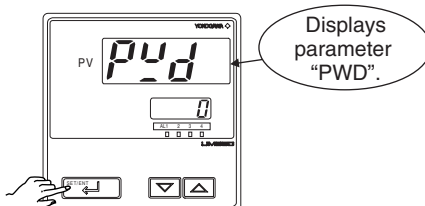

5. Press the key once to display the menu "FUNC".

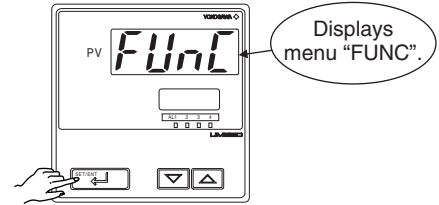

6. Press the key once to display the parameter "AL1" (alarm-1 type).

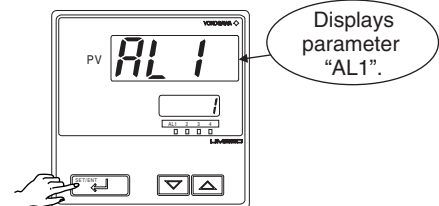

7. Press the or key to display the required setpoint. The figure below shows an example of setting PV low limit alarm.

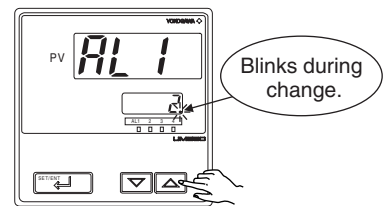

8. Press the  key once to register the setpoint.

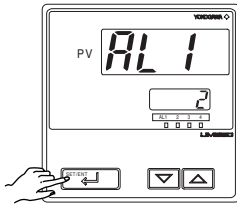

You can take the same steps for alarm-2 type (AL2), alarm-3 type (AL3), and alarm-4 type (AL4) that are displayed after this.

9. Press the  key for more than 3 seconds. This returns you to the display shown at power-on (figure below).

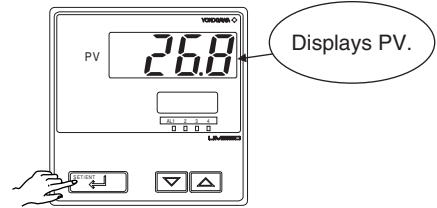

See “3.2 Setting Alarm Setpoints” when setting an alarm setpoint.

List of Alarm Types

The table below shows the alarm types and alarm actions. In the table, codes 1, 2, 9, and 10 are not provided with stand-by actions, while codes 11, 12, 19, and 20 are provided with stand-by actions.

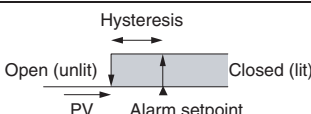
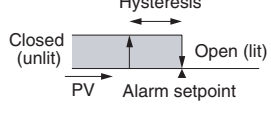
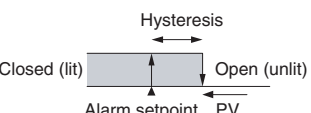
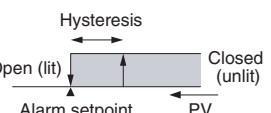
Alarm type	Alarm action “Open/close” shows status of relay contact, and “lit” and “unlit” shows status of lamp	Alarm type code		Alarm type	Alarm action “Open/close” shows status of relay contact, and “lit” and “unlit” shows status of lamp	Alarm type code	
		Contact closes if alarm occurs	Contact opens if alarm occurs			Contact closes if alarm occurs	Contact opens if alarm occurs
No alarm		OFF					
PV high limit		1	/	De-energized on PV high limit			9
		11					19
PV low limit		2	/	De-energized on PV low limit			10
		12					20
Fault diagnosis output (Note 1)		21	/	FAIL output (Note 2)			22

Note 1: Fault diagnosis output
Turns on in case of input burnout, A/D converter failure, or reference junction compensation (RJC) failure.

Note 2: FAIL output
Turns off in case of program failure, ROM failure, RAM failure, or power failure. This output is on during normal operation. If it turns off, the retransmission output is set to 0%, the alarm output is set to OFF, and the indicator stops.

Stand-by Action

It is effective in the following cases where;

- the power is turned on
- the alarm type is changed

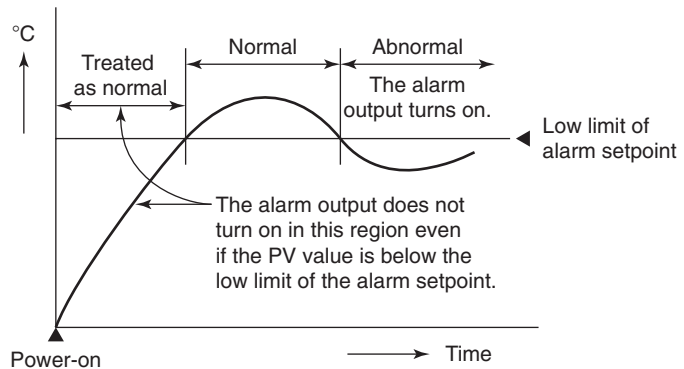

2.5 Setting Hysteresis in Alarm Setpoint

The following operating procedure describes an example of setting a 5.0°C hysteresis level in the alarm setpoint.

1. Bring the operating display into view (appears at power-on).

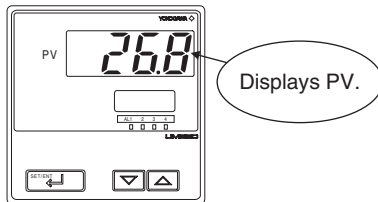

2. Press the  key for more than 3 seconds to call up the menu "OP.PA".

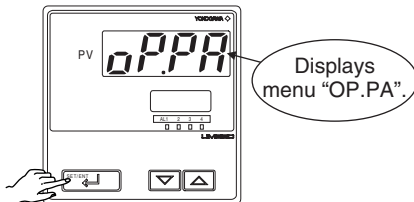

3. Press the  key once to display the menu "STUP".

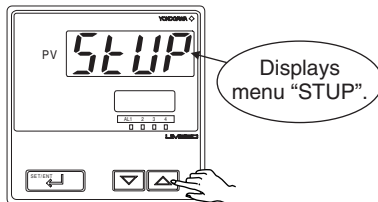

4. Press the  key once to display the parameter "PWD".

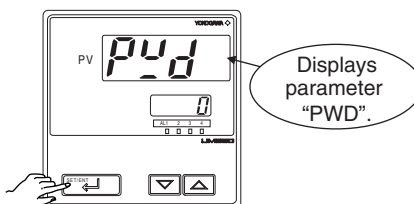

5. Press the  key once to display the menu "FUNC".

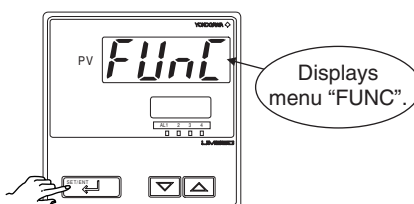

6. Press the  key several times to display the parameter "HY1" (alarm-1 hysteresis).

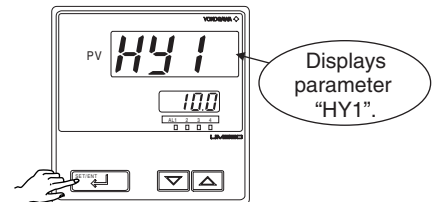

7. Press the  or  key to display the required setpoint.

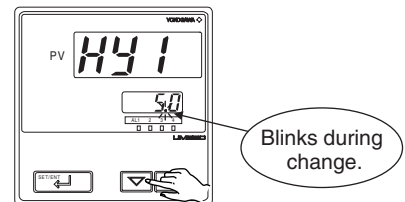

8. Press the  key once to register the setpoint.

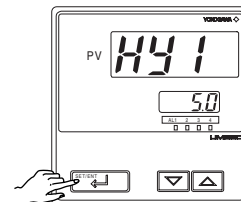





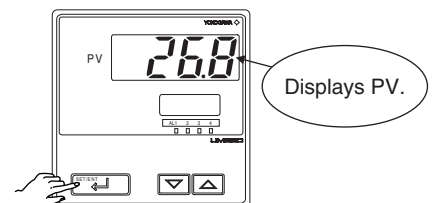







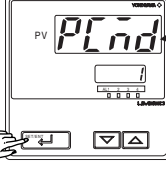

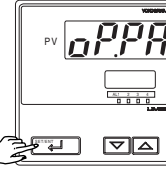

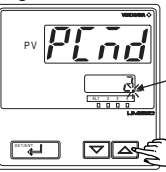
You can take the same steps for alarm-2 hysteresis (HY2), alarm-3 hysteresis (HY3), and alarm-4 hysteresis (HY4) that are displayed after this.

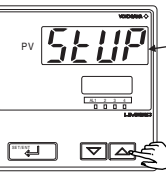
9. Press the  key for more than 3 seconds. This returns you to the display shown at power-on (figure below).

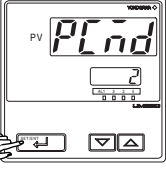

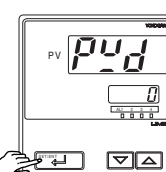

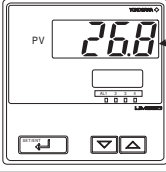

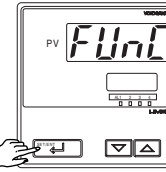



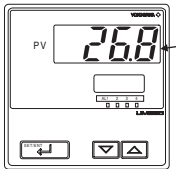

2.6 Setting the PV display color changing function “Active Color PV Display”

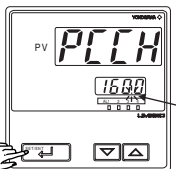
The following operating procedure describes an example of changing PV color mode (factory-set default: Fixed in red mode) to Link to alarm 1 mode.

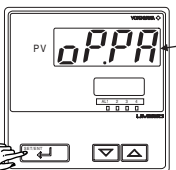
<p>(1) Bring the operating display into view (appears at power on).</p>  <p>Displays PV.</p>	<p>(6) Press the  key several times to display the menu “PCMD” (PV color mode).</p>  <p>Displays parameter “PCMD”</p>
<p>(2) Press the  key for more than 3 seconds to call up the menu “OP.PA.”</p>  <p>Displays menu “OP.PA.”</p>	<p>(7) Press the  key or  key to display the required setpoint. The figure below shows an example of setting Link to alarm 1 mode.</p>  <p>Blinks during change</p>
<p>(3) Press the  key once to display the menu “STUP.”</p>  <p>Displays menu “STUP”</p>	<p>(8) Press the  key once to register the setpoint.</p>  <p>If PCMD = 6, 7, 8 or 9, also set the relating parameters PCCH (High limit for PV color change) and PCCL (Low limit for PC color change).</p>
<p>(4) Press the  key once to display the parameter “PWD.”</p>  <p>Displays menu “PWD”</p>	<p>(9) Press the  key for more than 3 seconds. This returns you to the display shown at power-on (figure blow).</p>  <p>Displays PV.</p>
<p>(5) Press the  key once to display the menu “FUNC.”</p>  <p>Displays menu “FUNC”</p>	

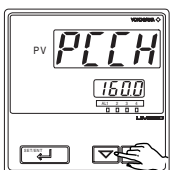
2.7 Setting the High Limit and Low limit for PV Color change

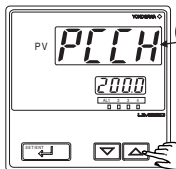
The following operating procedure describes an example of changing PV display color by linking to PV. Set High limit and Low limit for PV color change. Setting for both of High limit and Low limit is required.

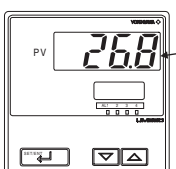
<p>(1) Bring the operating display into view (appears at power-on).</p>  <p>Displays PV.</p>	<p>(4) Press the  key or  key to display the required setpoint.</p>  <p>Blinks during change.</p>
<p>(2) Press the  key for more than 3 seconds to call up the menu "OP.PA."</p>  <p>Displays menu "OP.PA."</p>	<p>(5) Press the  key once to register the setpoint.</p>  <p>PCCL (Low limit for PV color change parameter) that is displayed after this can be</p>
<p>(3) Press the  key several times to display the parameter "PCCH."</p>  <p>Displays parameter "PCCH."</p>	<p>(6) Press the  key for more than 3 seconds. This returns you to the display shown at power-on (figure below).</p>  <p>Displays PV.</p>

Blank Page

3. Operations

This chapter describes key entries for operating the indicator. If you cannot remember how to carry out an operation during setting, press the  key for more than 3 seconds. This brings you to the display (operating display) that appears at power-on.

 **NOTE**

Do not use the instrument generating strong magnetic field such as radio equipment and the like near the indicator. This may cause the fluctuation of the PV value.

3.1 Monitoring-purpose Operating Display Available during Operation

The following is the monitoring-purpose operating display available during operation.

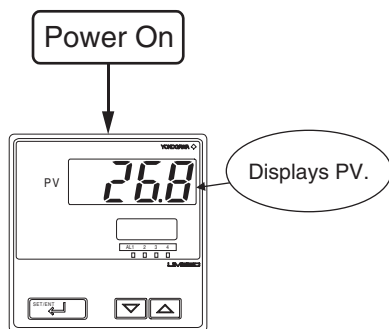

3.2 Setting Alarm Setpoints

The following operating procedure describes an example of setting a value of 160.0 in the alarm-1 setpoint parameter. Before setting the alarm setpoint, check the alarm type. To change the alarm type, see “2.4 Changing Alarm Type.”

Alarm output terminals	Factory-set defaults
Alarm-1 (terminal numbers ⑥-⑦)	PV high limit alarm
Alarm-2 (terminal numbers ⑤-⑦)	PV low limit alarm
Alarm-3 (terminal numbers ④-⑦)	PV high limit alarm
Alarm-4 (terminal numbers ①-②-③)	PV low limit alarm

1. Bring the operating display into view (display appears at power on).

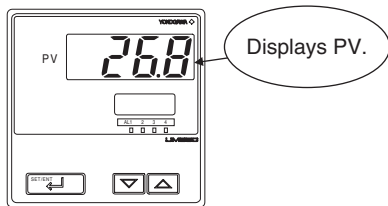

2. Press the key for more than 3 seconds to call up the menu “OP.PA”.

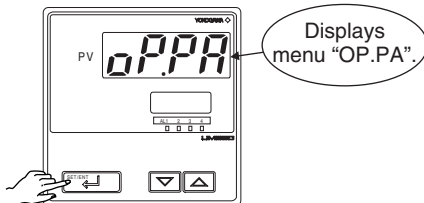

3. Press the key once to display the parameter “A1”.

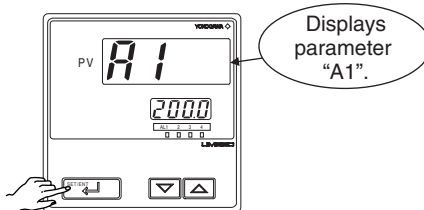

4. Press the or key to display the required setpoint.

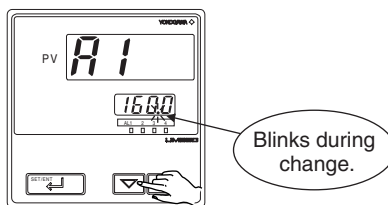

5. Press the key once to register the setpoint.

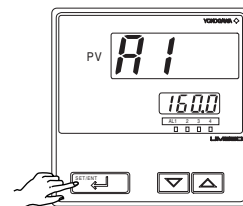

You can take the same steps for alarm-2 setpoint (A2), alarm-3 setpoint (A3), and alarm-4 setpoint (A4) that are displayed after this.

6. Press the key for more than 3 seconds. This returns you to the display shown at power-on (figure below).

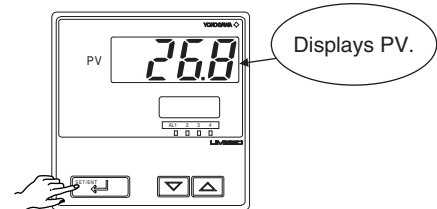

4. Troubleshooting and Maintenance

4.1 Troubleshooting

■ Troubleshooting Flow

If the operating display does not appear after turning on the indicator's power, try to solve the problem by following the procedure below.

If the problem seems to be complex, contact the vendor from which you purchased the instrument.

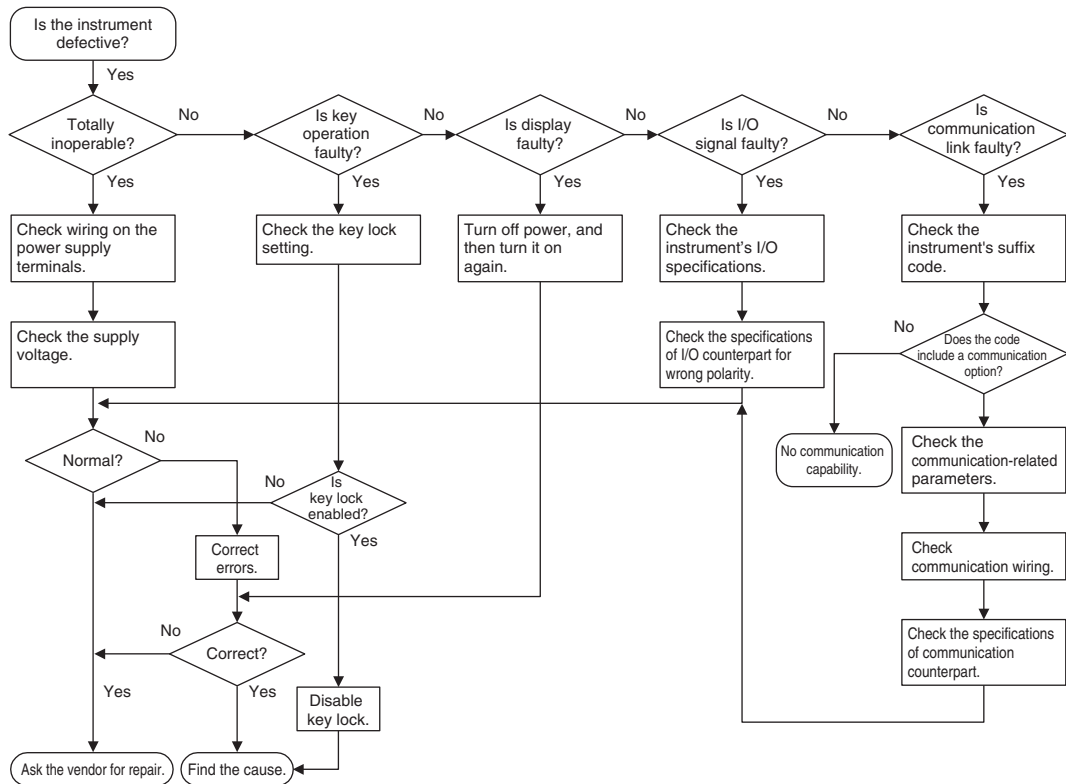

IMPORTANT

Take note of the parameter settings when asking the vendor for repair.

■ Errors at Power on

The following table shows errors that may be detected by the fault diagnosis function when the power is turned on.

Error indication (on PV display unit)	Description of error	PV	Control output	Alarm output	Retransmission output	Communication	Remedy
<i>E000</i> (E000)	Faulty RAM	None	0% or less or OFF	OFF	0% or less	Stopped	Faulty Contact us for repair.
<i>E001</i> (E001)	Faulty ROM				0%		
<i>E002</i> (E002)	System data error	0%			0%		
PV decimal point blinks.	Faulty calibration value	Normal action (out of accuracy)	Normal action (out of accuracy)	Normal action (out of accuracy)	Normal action (out of accuracy)	Normal action	Check and set the parameters, as they have been set to the limited values.
<i>E400</i> (E400)	Parameter error	0%	Preset value	OFF	0%		

■ Possible Errors during Operation

The following shows possible errors occurring during operations.

Error indication (on PV display unit)	Description of error	PV	Control output	Alarm output	Retransmission output	Communication	Remedy
Displays "RJC" and PV alternately	RJC error	Measured with RJC=OFF	Normal action	Normal action	Normal action	Normal action	Faulty Contact us for repair.
PV value blinks.	EEPROM error	Normal action	Normal action	Normal action	Normal action	Normal action	Faulty Contact us for repair.
<i>E300</i> (E300)	A/DC error	105%	Preset value	Normal action	Normal action	Normal action	
<i>b.o.u.t</i> (B.OUT)	PV burnout error	Dependent on the BSL parameter Up-scale: 105% Down-scale: -5%	Preset value	Normal action	Normal action	Normal action	Check wires and sensor.
<i>o.v.e.r</i> (OVER) or <i>-o.v.e.r</i> (-OVER)	Excessive PV Out of -5 to 105%	-5% or 105%	Normal action	Normal action	Normal action	Normal action	Check process.
SP decimal point blinks. (on setpoint display unit)	Faulty communication line	Normal action	Normal action	Normal action	Normal action	Normal action	Check wires and communication parameters, and make resetting. Recovery at normal receipt
All indications off	Runaway (due to defective power or noise)	None	0% or less or OFF	OFF	0% or less	Stopped	Faulty if power off/on does not reset start the unit. Contact us for repair.
All indications off	Power off	None	0%	OFF	0%	Stopped	Check for abnormal power.

■ If a Power Failure Occurs during Operation

● Momentary Power Failures shorter than 20 ms

The indicator is not affected at all and continues normal operation.

● Momentary Power Failures of 20 ms or longer

- The alarm function of the indicator continues to work normally. (Alarms with the stand-by feature temporarily return to their stand-by state, however.)
- Setting parameters that have already been configured retain their settings.

4.2 Maintenance

This section describes the cleaning and maintenance of the UM351/UM331.

4.2.1 Cleaning

The front panel and operation keys should be gently wiped with a dry cloth.



NOTE

Do not use alcohol, benzine, or any other solvents.

4.2.2 Replacing Brackets

When the brackets are broken or lost, purchase the following brackets for replacement.

Target Model	Part No.	Sales Unit
UM351	T9115NL	A large bracket and small bracket in pair
UM331	T9115NK	Small brackets in pair

SEE ALSO

“1.2 How to Install,” for how to replace brackets.

4.2.3 Attaching Terminal Cover

When a terminal cover is necessary, purchase the following part.

Target Model	Part No.	Sales Unit
UM351	T9115YD	1
UM331	T9115YE	1

■ Attaching Terminal Cover

The procedure for attaching the terminal cover is as follows.



Do not touch the terminals on the rear panel when power is being supplied to the indicator. Doing so may result in electric shock.

Before attaching the terminal cover, turn off the source circuit breaker and use a tester to check that the power cable is not conducting any electricity.

1. Before attaching the terminal cover, fold it once or twice so that the side which has the “Handle With Care” symbol (⚠), is on the outside.

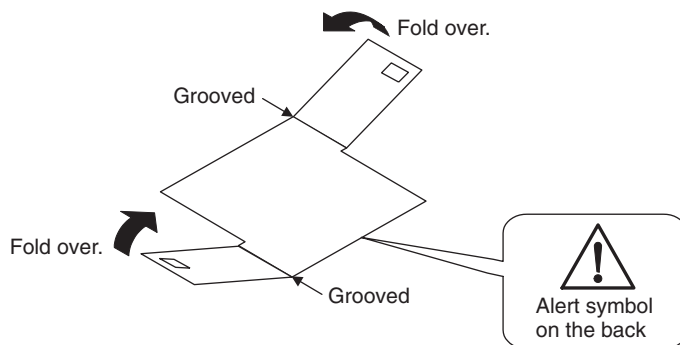

Folding Direction of Terminal Cover



Do not fold the terminal cover the wrong way, doing so not only reduces the cover’s strength but may also cause the hinge to crack, thereby disabling attachment.

2. With the cover properly folded, fit its top and bottom holes to the protrusions of the mounting brackets.

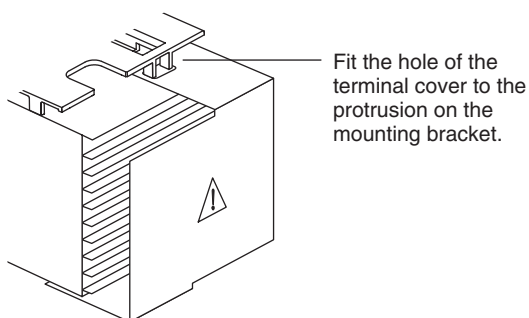

Attaching Terminal Cover

4.2.4 Replacing Parts with a Limited Service Life

The following UM351/UM331 parts have a limited service life.

The service life given in the table assume that the indicator is used under normal operating conditions.

Part	Service life
Aluminum electrolytic condenser	About 10 years (rated)
EEPROM	About 100,000 times of writings
Alarm 4 output relays	About 100,000 more ON-OFF operations or with resistance load

5. Parameters

This chapter contains a parameter map as a guideline for setting parameters, and lists of parameters for recording User Settings.

5.1 Parameter Map

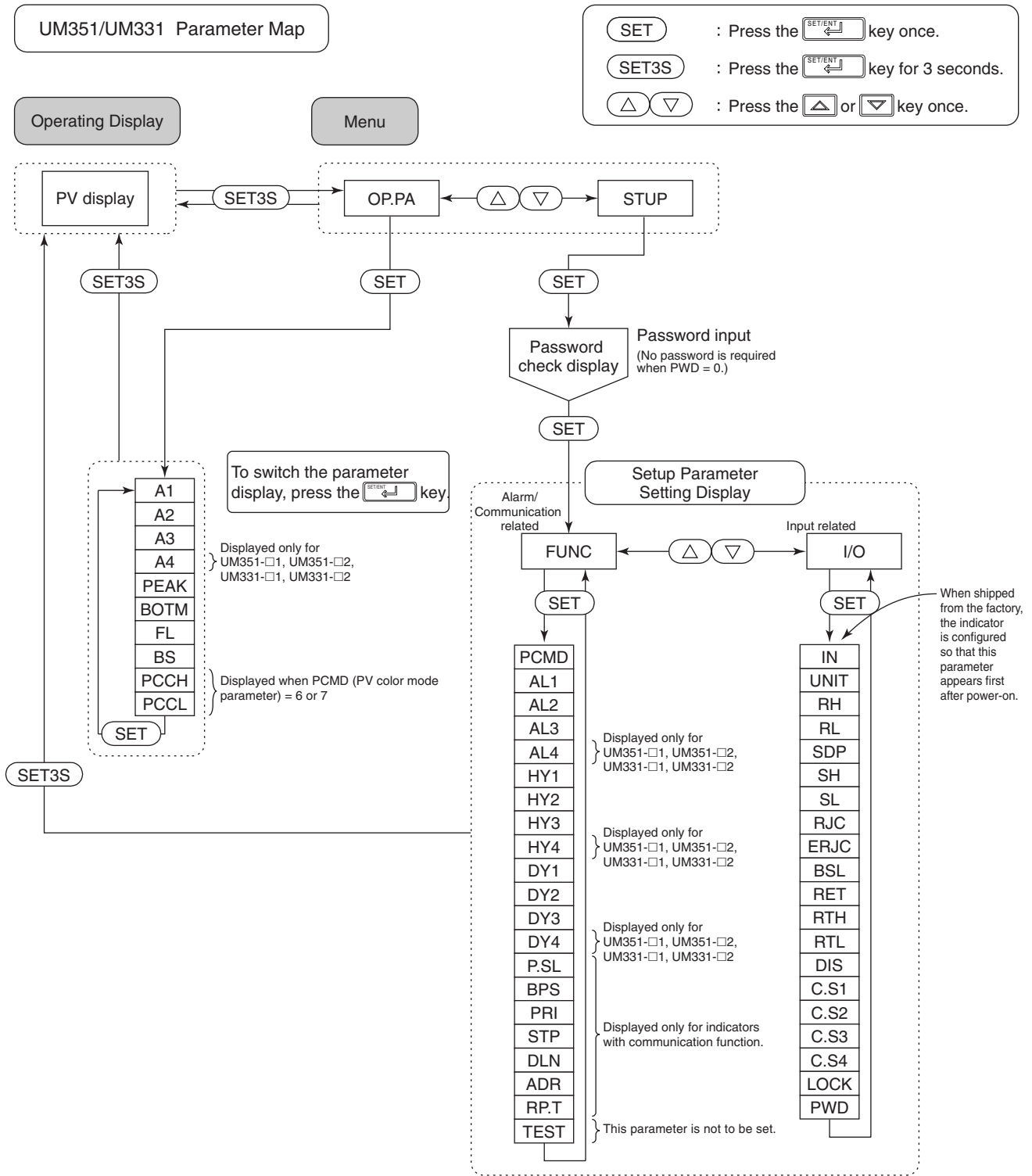

5.2 Lists of Parameters

- * Parameters relating to PV should all be set in real numbers. For example, use temperature values to define alarm setpoints for temperature input.
- * The “User Setting” column in the table is provided for the customer to record setpoints.
- * Numbers in () are the parameter setpoints that apply when the communication function is used. ex. OFF (0), ON(1)

■ Operating Parameters

Parameter Symbol	Name of Parameter	Setting Range and Description		Initial Value	User setting
A1 (A1)	Alarm 1-setpoint	PV alarm: -100.0 to 100.0% of PV input range		PV high limit alarm: 100.0% of PV input range PV low limit alarm: 0.0% of PV input range	
A2 (A2)	Alarm 2-setpoint				
A3 (A3)	Alarm 3-setpoint				
A4 (A4)	Alarm 4-setpoint				
PEAK (PEAK)	PV peak value	Displays the maximum value of PV input during operation. This parameter is not to be set.			
botn (BOTM)	PV bottom value	Displays the minimum value of PV input during operation. This parameter is not to be set.			
FL (FL)	PV input filter	OFF (0), 1 to 120 sec. Used when the PV input fluctuates.		OFF (0)	
BS (BS)	PV input bias	-100.0% to 100.0% of PV input range span Used to correct the PV input value.		0.0% of PV input range span	
PCCH (PCCH)	High limit for PV color change	When PCMD (PV color mode parameter) = 6 or 7 : -100.0 to 100.0 % of PV input range		When PCMD = 6 or 7 : PCCH = 100.0%, PCCL = 0.0 %	
PCCL (PCCL)	Low limit for PV color change				

■ Setup Parameters

● Alarm/Communication Related Parameters

Parameter Symbol	Name of Parameter	Setting Range and Description	Initial Value	User Setting
PCnd (PCMD)	PV color mode	0: Fixed in green 1: Fixed in red 2: Link to alarm 1 (Alarm OFF:green, Alarm ON:red) 3: Link to alarm 1 (Alarm OFF:red, Alarm ON:green) 4: Link to alarm 1 and 2 (Alarm OFF:green, Alarm ON:red) 5: Link to alarm 1 and 2 (Alarm ON:red, Alarm OFF:green) 6: PV limit (Within PV range:green, Out of PV range:red) 7: PV limit (Within PV range:red, Out of PV range:green)	1	
AL1 (AL1)	Alarm-1 type	OFF (0) 1: PV high limit (energized, no stand-by action) 2: PV low limit (energized, no stand-by action) 9: PV high limit (de-energized, no stand-by action) 10: PV low limit (de-energized, no stand-by action) 11: PV high limit (energized, stand-by action) 12: PV low limit (energized, stand-by action) 19: PV high limit (de-energized, stand-by action) 20: PV low limit (de-energized, stand-by action) 21: Fault diagnosis output Turns on in case of input burnout, A/D converter failure, or reference junction compensation (RJC) failure.	1	
AL2 (AL2)	Alarm-2 type	22: FAIL output Turns off in case of program failure, ROM failure, RAM failure, or power failure. This output is on during normal operation. If it turns off, the retransmission output is set to 0%, the alarm output is set to OFF, and the indicator stops.	2	
AL3 (AL3)	Alarm-3 type	See "List of Alarm Types" for details on how these Alarm Type parameters behave.	1	
AL4 (AL4)	Alarm-4 type		2	
HY1 (HY1)	Alarm-1 hysteresis	0.0 to 100.0% of PV input range span Hysteresis can be set in the alarm setpoint. Setting hysteresis prevents relays from chattering.	0.5% of PV input range span	Output alarms 0.5%
HY2 (HY2)	Alarm-2 hysteresis	<p>Hysteresis setting for PV high limit alarm</p>		
HY3 (HY3)	Alarm-3 hysteresis			
HY4 (HY4)	Alarm-4 hysteresis			
DY1 (DY1)	Alarm-1 delay timer		An alarm is output when the delay timer expires after the alarm setpoint is reached. 0.00 to 99.59 (min, sec.) (enabled when alarm-1 type "AL1" is 1, 2, 9, 10, 11, 12, 19, and 20)	0.00
DY2 (DY2)	Alarm-2 delay timer	0.00 to 99.59 (min, sec.) (enabled when alarm-2 type "AL2" is 1, 2, 9, 10, 11, 12, 19, and 20)		
DY3 (DY3)	Alarm-3 delay timer	0.00 to 99.59 (min, sec.) (enabled when alarm-3 type "AL3" is 1, 2, 9, 10, 11, 12, 19, and 20)		
DY4 (DY4)	Alarm-4 delay timer	0.00 to 99.59 (min, sec.) (enabled when alarm-4 type "AL4" is 1, 2, 9, 10, 11, 12, 19, and 20)		

Parameter Symbol	Name of Parameter	Setting Range and Description	Initial Value	User Setting
P.SL (P.SL)	Protocol selection	0: PC link communication 1: PC link communication (with sum check) 2: Ladder communication 7: MODBUS (ASCII) 8: MODBUS (RTU)	0	
bPS (BPS)	Baud rate	0: 600, 1: 1200, 2: 2400, 3: 4800, 4: 9600 (bps)	4	
P.rI (PRI)	Parity	0: None 1: Even 2: Odd	1	
StP (STP)	Stop bit	1, 2	1	
dLn (DLN)	Data length	7, 8 Fixed at 7, when the P.SL parameter is set to MODBUS (ASCII). Fixed at 8, when the P.SL parameter is set to MODBUS (RTU) or Ladder Communication.	8	
Adr (ADR)	Address	1 to 99 However, the maximum number of stations connectable is 31.	1	
rPt (RP.T)	Minimum response time	0 to 10 (× 10 ms)	0	
tEst (TEST)	If this parameter symbol appears, press the SET/ENT key to return to the FUNC menu. Caution: Do not change the setpoint of the TEST parameter, otherwise the indicator will be disabled.			

● Input-/Output-related Parameters

Parameter Symbol	Name of Parameter	Setting Range and Description	Initial Value	User Setting
In (IN)	PV input type (PV INPUT terminals) ⑪-⑫-⑬ terminals	OFF, 1 to 18, 30, 31, 35 to 37, 40, 41, 50, 51, 55, 56 See Instrument Input Range Codes in “2. Initial Settings.”	OFF (0)	
Unit (UNIT)	PV input unit	°C (0): degree Celsius °F (5): Fahrenheit	°C (0)	
rH (RH)	Max. value of PV input range	Set the PV input range, however RL < RH - Temperature input Set the range of temperature that is actually indicated. - Voltage input Set the range of a voltage signal that is applied.	Max. value of instrument input range	
rL (RL)	Min. value of PV input range	The scale across which the voltage signal is actually indicated should be set using the parameters Maximum Value of PV Input Scale (SH) and Minimum Value of PV Input Scale (SL).	Min. value of instrument input range	
SDP (SDP)	PV input decimal point position (displayed at voltage input)	0 to 3 Set the position of the decimal point of voltage-mode PV input. 0: No decimal place 1: One decimal place 2, 3: Two, three decimal places	1	
SH (SH)	Max. value of PV input scale (displayed at voltage input)	-1999 to 9999, however SL < SH Set the read-out scale of voltage-mode PV input.	100.0	
SL (SL)	Min. value of PV input scale (displayed at voltage input)		0.0	
BSL (BSL)	Selection of PV input burnout action	OFF (0) 1: Up scale 2: Down scale	1	
rJC (RJC)	Presence/absence of PV input reference junction compensation	OFF (0), ON (1)	ON (1)	
ErJC (ERJC)	External RJC setpoint	-50.0 to 50.0 °C -58.0 to 122.0 °F	0.0 °C 32.0 °F	

Parameter Symbol	Name of Parameter	Setting Range and Description	Initial Value	User Setting
RET (RET)	Retransmission output type	1: PV 2, 3: Do not use 4: Loop power supply for sensor (15 V)	1	
RTH (RTH)	Max. value of retransmission output scale	RET=1: RTL + 1 digit to 100.0% of PV input range	100.0% of PV input range	
RTL (RTL)	Min. value of retransmission output scale	RET=1: 0.0% of PV input range to RTH - 1 digit	0.0% of PV input range	
DIS (DIS)	DI function selection	OFF (0): The external contact input is disabled. 1: Resets the values of the PEAK and BOTM operating parameters to an off-to-on transition of the DI1 input.	1	
C.S1 (C.S1)	SELECT display-1 registration	OFF (0), 201 to 1015 For example, registering "231" for C.S1 allows you to change alarm-1 setpoint in operating display.	OFF (0)	
C.S2 (C.S2)	SELECT display-2 registration	Numbers for registering alarm SP parameter for operating display: Alarm-1 setpoint: 231 Alarm-2 setpoint: 232 Alarm-3 setpoint: 233 Alarm-4 setpoint: 234		
C.S3 (C.S3)	SELECT display-3 registration			
C.S4 (C.S4)	SELECT display-4 registration			
LOCK (LOCK)	Key lock		OFF (0): No key lock 1: Change to any parameter prohibited Prohibits any operating parameter or setup parameter from being changed. The setpoint of the LOCK parameter itself can be changed, however. 2: Change to and display of operating parameters prohibited Turns off the display for setting operating parameters, thus prohibiting any change to the parameter settings. (Press the SET/ENT key for more than 3 seconds to show the password check display.)	OFF (0)
PWD (PWD)	Password setting	0: Password not set 1 to 9999	0	

List of Alarm Types

The table below shows the alarm types and alarm actions.

In the table, codes 1, 2, 9, and 10 are not provided with stand-by actions, while codes 11, 12, 19, and 20 are provided with stand-by actions.

Alarm type	Alarm action "Open/close" shows status of relay contact, and "lit" and "unlit" shows status of lamp	Alarm type code		Alarm type	Alarm action "Open/close" shows status of relay contact, and "lit" and "unlit" shows status of lamp	Alarm type code	
		Contact closes if alarm occurs	Contact opens if alarm occurs			Contact closes if alarm occurs	Contact opens if alarm occurs
No alarm		OFF					
PV high limit		1	/	De-energized on PV high limit		9	/
		11		19			
PV low limit		2	/	De-energized on PV low limit		10	/
		12		20			
Fault diagnosis output (Note 1)		21	/	FAIL output (Note 2)			22

Note 1: Fault diagnosis output

Turns on in case of input burnout, A/D converter failure, or reference junction compensation (RJC) failure.

Note 2: FAIL output

Turns off in case of program failure, ROM failure, RAM failure, or power failure. This output is on during normal operation.

If it turns off, the retransmission output is set to 0%, the alarm output is set to OFF, and the indicator stops.

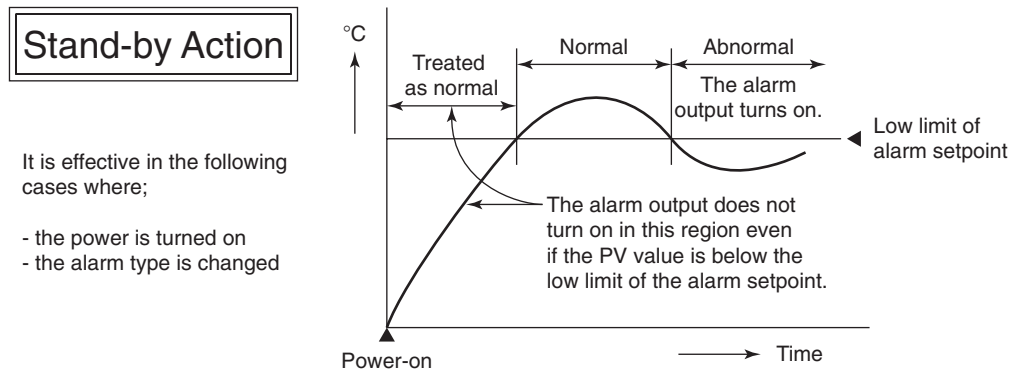

● Behavior of the PV High-limit Alarm Parameter (Alarm Type Code: 1)

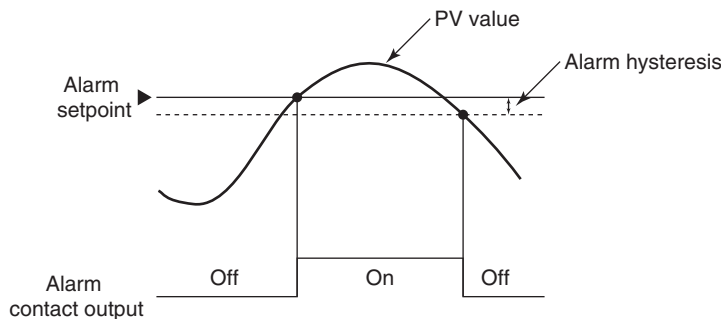

■ Functions of Active Color PV Display

This part describes the functions of “Active Color PV Display.” PV display color is changed by the following four actions.

PV display is selectable from red-to-green or green-to-red changing action, or fixed color.

Link to alarm 1 mode (when PCMD = 2, 3) (Setting example-1)

Link to alarm 1 and 2 mode (when PCMD = 4, 5) is the same. When either of the alarms occurs, the display color is changed.

PV limit mode (when PCMD = 6, 7) (Setting example-2)

Fixed color mode (when PCMD = 0, 1) (Setting example-3)

Setting Example-1 : Link to Alarm

Works linked to alarm 1.

Set “PV high limit alarm” for alarm 1 type, and “80°C” for alarm 1 setpoint.

If PCMD (PV color mode parameter) = 2, PV display color is changed from green to red when PV input value exceeds alarm 1 setpoint.

The red-to-green changing action is selectable.

Setting parameters

PCMD (PV color mode parameter) = 2

AL1 (Alarm 1 type parameter) = 1

A1 (Alarm 1 setpoint parameter) = 80°C

HY1 (Alarm 1 hysteresis parameter) = 5°C

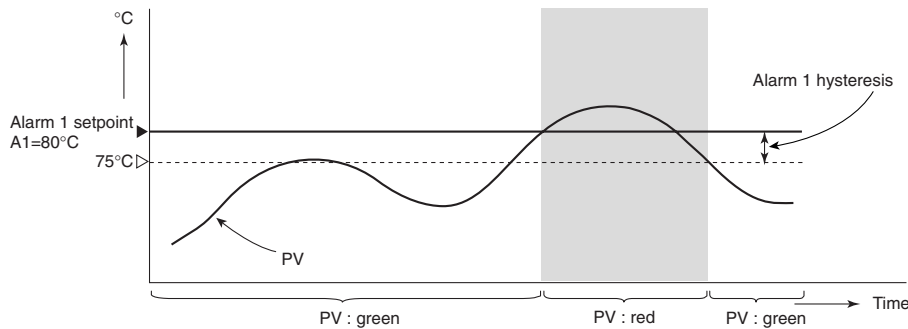

Setting Example-2 : Link to PV

Set high limit “70°C” for PCCH, and low limit “20°C” for PCCL.

PV display color is changed from green to red when PV input value is out of the range.

The red-to-green changing action is selectable.

Setting parameters

PCMD (PV color mode parameter) = 6

PCCH (High limit for PV color change parameter) = 70°C

PCCL (Low limit for PV color change parameter) = 20°C

Hysteresis fixed to 0.25% is inserted where PV display color is changed.

In the example blow, where changed from red to green.

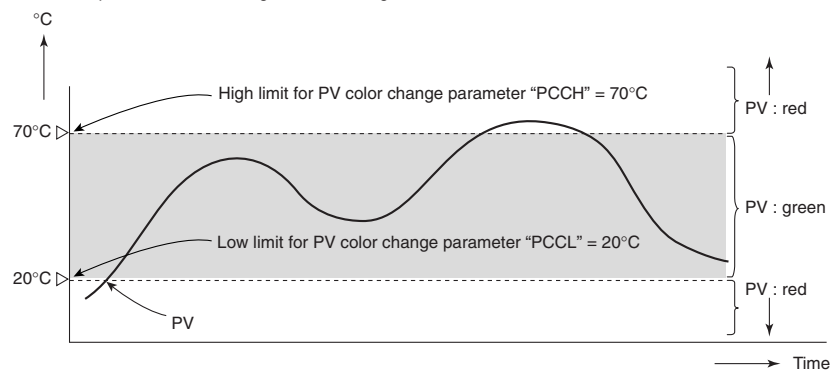

Setting Example-3 : Fixed in Red or Green

Set the PV display color or Fixed in green mode, Setting of Fixed to red mode is also possible.
 Setting parameter
 PCMD (PV color mode parameter) = 0

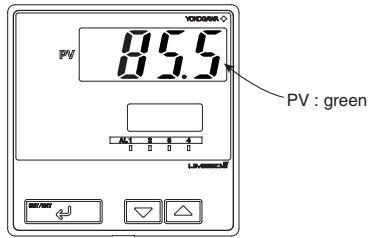

External RJC

External RJC is not a compensation function built in a indicator but a compensation function working outside the indicator.

External RJC is used when input is thermocouple, and RJC=OFF.

Using External RJC makes the accuracy of RJC higher and shortens the compensating wire.

Parameter Symbol	Name of Parameter	Setting Range	Initial Value
ERJC (ERJC)	External RJC setpoint	-50.0 to 50.0°C, -58.0 to 122.0°F For thermocouple input, temperature compensation value outside the indicator can be set. Available only when RJC=OFF.	0.0°C 32.0°F

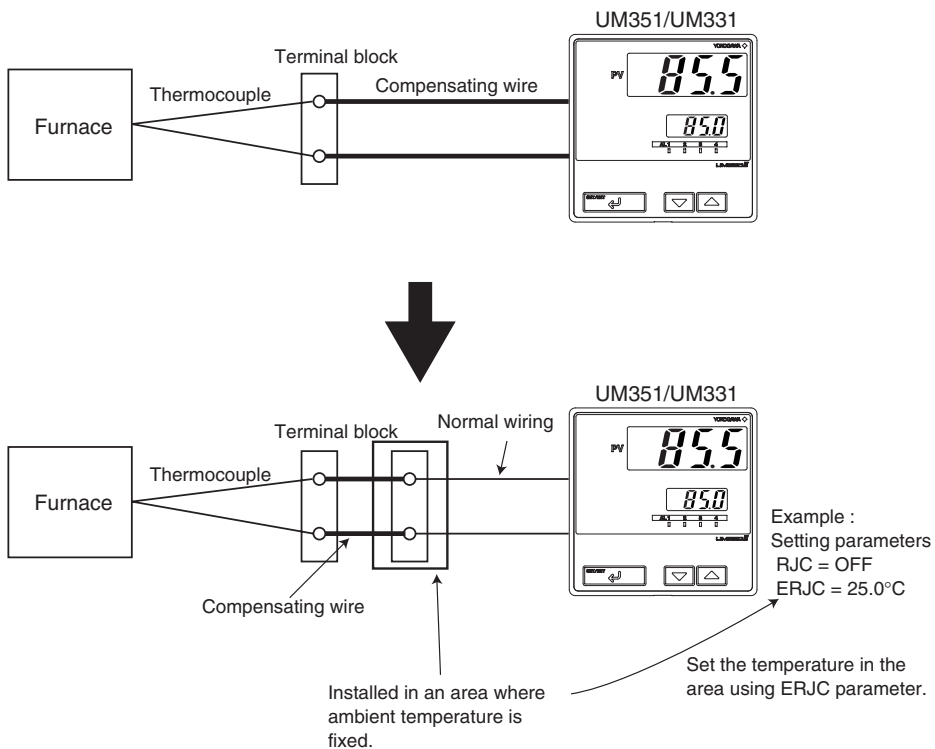

■ Useful Operating Display (SELECT Display)

Registering frequently changed parameters in the SELECT display after ordinary operating displays will allow you to change settings easily. A maximum of four displays can be registered.

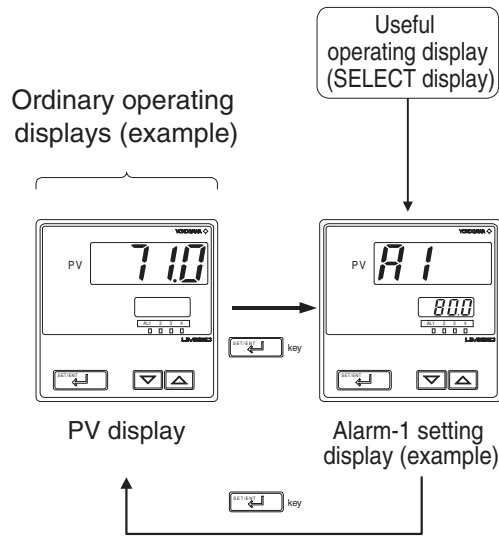

<Setting Method>

Set the parameter numbers (D register numbers) you wish to register for setup parameters C.S1 to C.S4.

● Numbers for Registration with SELECT Display

Operating Parameter	Registration Number	Setup Parameter	Registration Number
Alarm-1 setpoint (A1)	231	Alarm-1 hysteresis	919
Alarm-2 setpoint (A2)	232	Alarm-2 hysteresis	920
Alarm-3 setpoint (A3)	233	Alarm-3 hysteresis	921
Alarm-4 setpoint (A4)	234	Alarm-4 hysteresis	922
Bias (BS)	243		
Filter (FL)	244		

For any registration number other than those above, see User's Manual (Reference) (CD-ROM version).

Blank Page

Revision Information

- Title : Models UM351/UM331 Digital Indicator with Alarms User's Manual
- Manual No. : IM 05F01D12-41E

May 2003/1st Edition

Newly published

Sep 2003/2nd Edition

Complies with safety and EMC standards.

Jul 2004/3rd Edition

Change of the company name

May 2006/4th Edition

Revision by the change of safety standard description

Written by Yokogawa Electric Corporation

Published by Yokogawa Electric Corporation
2-9-32 Nakacho, Musashino-shi, Tokyo 180-8750, JAPAN

Blank Page

YOKOGAWA

Yokogawa Electric Corporation

YOKOGAWA ELECTRIC CORPORATION

Network Solutions Business Division

2-9-32, Nakacho, Musashino-shi, Tokyo, 180-8750 JAPAN

Phone: +81-422-52-7179 Facsimile: +81-422-52-6793

Sales Branch Offices

Tokyo, Nagoya, Osaka, Hiroshima, Fukuoka

YOKOGAWA CORPORATION OF AMERICA

Headquarters

2 Dart Road, Newnan, GA. 30265-1094 U.S.A.

Phone: +1-770-253-7000 Facsimile: +1-770-251-0928

Sales Branch Offices / Texas, Chicago, Detroit, San Jose

YOKOGAWA EUROPE B. V.

Headquarters

Databankweg 20, 3821 AL Amersfoort THE NETHERLANDS

Phone: +31-334-64-1611 Facsimile: +31-334-64-1610

Sales Branch Offices / Houten (The Netherlands), Wien (Austria), Zaventem (Belgium), Ratingen (Germany), Madrid (Spain), Bratislava (Slovakia), Runcorn (United Kingdom), Milano (Italy), Vélizy villacoublay(France), Johannesburg(Republic of South Africa)

YOKOGAWA AMERICA DO SUL S.A.

Headquarters & Plant

Praca Acapulco, 31-Santo Amaro, Sao Paulo/SP, BRAZIL CEP-04675-190

Phone: +55-11-5681-2400 Facsimile: +55-11-5681-4434

YOKOGAWA ENGINEERING ASIA PTE. LTD.

Head office

5 Bedok South Road, Singapore 469270 SINGAPORE

Phone: +65-6241-9933 Facsimile: +65-6241-2606

YOKOGAWA ELECTRIC KOREA CO., LTD.

Seoul Sales office

395-70, Shindaebang-dong, Dongjak-gu, Seoul,156-010, KOREA

Phone: +82-2-3284-3000 Facsimile: +82-2-3284-3019

YOKOGAWA TAIWAN CORPORATION

Head office

17F, No.39, Sec. 1, Chung Hwa Road Taipei, 100 TAIWAN

Phone: +886-2-2314-9166 Facsimile: +886-2-2314-9918

YOKOGAWA AUSTRALIA PTY. LTD.

Head office

CentreCourt D1, 25-27 Paul Street North, North Ryde, N. S. W. 2113, AUSTRALIA

Phone: +61-2-9805-0699 Facsimile: +61-2-9888-1844

YOKOGAWA INDIA LTD.

Head office

40/4 Lavelle Road, Bangalore, 560 001, INDIA

Phone: +91-80-227-1513 Facsimile: +91-80-227-4270

LTD. YOKOGAWA ELECTRIC

Grokholskiy per. 13, Build. 2, 4th Floor, 129010, Moscow, RUSSIA FEDERATION

Phone: +7-095-737-7868 Facsimile: +7-095-737-7869
